

**Part No. 060236-10, Rev. H  
December 2012**

# **OmniSwitch 6400 Series Hardware Users Guide**

Alcatel·Lucent 

[www.alcatel-lucent.com](http://www.alcatel-lucent.com)

---

**This user guide documents OmniSwitch 6400 Series hardware, including chassis and associated components for AOS Release 6.4.5. The specifications described in this guide are subject to change without notice.**

Copyright © 2012 by Alcatel-Lucent. All rights reserved. This document may not be reproduced in whole or in part without the express written permission of Alcatel-Lucent.

Alcatel-Lucent® and the Alcatel-Lucent logo are registered trademarks of Alcatel-Lucent. Xylan®, OmniSwitch®, OmniStack®, and Alcatel-Lucent OmniVista® are registered trademarks of Alcatel-Lucent.

OmniAccess™, Omni Switch/Router™, PolicyView™, RouterView™, SwitchManager™, VoiceView™, WebView™, X-Cell™, X-Vision™, and the Xylan logo are trademarks of Alcatel-Lucent.

This OmniSwitch product contains components which may be covered by one or more of the following U.S. Patents:

- U.S. Patent No. 6,339,830
- U.S. Patent No. 6,070,243
- U.S. Patent No. 6,061,368
- U.S. Patent No. 5,394,402
- U.S. Patent No. 6,047,024
- U.S. Patent No. 6,314,106
- U.S. Patent No. 6,542,507
- U.S. Patent No. 6,874,090



**26801 West Agoura Road  
Calabasas, CA 91301  
(818) 880-3500 FAX (818) 880-3505  
esd.support@alcatel-lucent.com**

**US Customer Support—(800) 995-2696  
International Customer Support—(818) 878-4507  
Internet—service.esd.alcatel-lucent.com**

# Contents

<b>Contents</b>	<b>About This Guide</b> .....	ix
	Supported Platforms .....	ix
	Who Should Read this Manual? .....	xi
	When Should I Read this Manual? .....	xi
	What is in this Manual? .....	xi
	What is Not in this Manual? .....	xi
	How is the Information Organized? .....	xii
	Documentation Roadmap .....	xii
	Related Documentation .....	xiv
	Published / Latest Product Documentation .....	xv
	Technical Support .....	xv
<b>Chapter 1</b>	<b>OmniSwitch 6400 Series</b> .....	1-1
	OmniSwitch 6400 Series Chassis Configurations .....	1-2
	Availability Features .....	1-3
	Software Rollback .....	1-3
	Backup Power Supplies .....	1-3
	Hot Swapping .....	1-4
	Hardware Monitoring .....	1-4
<b>Chapter 2</b>	<b>OmniSwitch 6400 Series Chassis and Hardware Components</b> .....	2-1
	OmniSwitch 6400 Series Chassis Configurations .....	2-1
	OmniSwitch 6400-24 Front Panel .....	2-2
	OmniSwitch 6400-24 Rear Panel .....	2-3
	OS6400-24 Specifications .....	2-4
	OmniSwitch 6400-P24 Front Panel .....	2-5
	OmniSwitch 6400-P24 Rear Panel .....	2-6
	OS6400-P24 Specifications .....	2-7
	OmniSwitch 6400-U24 Front Panel .....	2-8
	OmniSwitch 6400-U24 Rear Panel .....	2-9
	OS6400-U24 Specifications .....	2-10
	OmniSwitch 6400-U24D Front Panel .....	2-11
	OmniSwitch 6400-U24D Rear Panel .....	2-12
	OS6400-U24D Specifications .....	2-13
	OmniSwitch 6400-48 Front Panel .....	2-14
	OmniSwitch 6400-48 Rear Panel .....	2-15
	OS6400-48 Specifications .....	2-16
	OmniSwitch 6400-P48 Front Panel .....	2-17

OmniSwitch 6400-P48 Rear Panel .....	2-18
OS6400-P48 Specifications .....	2-19
LED Status Indicators .....	2-20
OmniSwitch 6400 Series Power Supplies .....	2-21
PS-510W-AC Power Supply .....	2-22
PS-510W-AC-E Power Supply .....	2-23
PS-360W-AC Power Supply .....	2-24
PS-360W-AC-E Power Supply .....	2-25
PS-126W-AC Power Supply .....	2-26
PS-120W-DC Power Supply .....	2-27
126W AC Internal Power Supply .....	2-28
120W DC Internal Power Supply .....	2-28
Power Supply Shelf .....	2-29
AC Power Cords .....	2-30
Specifications .....	2-30
DC Power Specifications .....	2-31
Console Port .....	2-32
Serial Connection Default Settings .....	2-32
Modifying the Serial Connection Settings .....	2-32
Port Pinouts .....	2-34
10/100 Ethernet Port – RJ-45 Pinout (non-PoE) .....	2-34
Gigabit Ethernet Port – RJ-45 Pinout .....	2-34
10/100/1000 Mbps Power over Ethernet Port – RJ-45 Pinout .....	2-34
RJ-45 Console Port – Connector Pinout .....	2-35
<b>Chapter 3</b>	
<b>Mounting OS6400 Switches .....</b>	<b>3-1</b>
General Mounting Recommendations .....	3-1
Recommended Clearances .....	3-1
Elevated Operating Ambient Temperatures .....	3-2
Reduced Air Flow .....	3-2
Mechanical Loading .....	3-2
Circuit Overloading .....	3-2
Reliable Earthing .....	3-2
Airflow Recommendations .....	3-3
Fan Speed Control .....	3-4
Installation Overview .....	3-5
Mounting Guidelines .....	3-5
Mounting Options .....	3-5
Tabletop Installation .....	3-6
Next Steps .....	3-7
Rack-Mount Installation .....	3-8
Rack Mount Guidelines .....	3-8
Rack Mounting Steps .....	3-8
Next Steps .....	3-9
Setting Up a Stacked Configuration .....	3-10
Rack Mounting Stacked Configurations .....	3-10

Cabling Stacked Configurations .....	3-10
Redundant Stacking Cable Connections .....	3-10
Recommended Cabling Patterns .....	3-10
Installing Power Supplies .....	3-13
Connecting a Power Supply to the Chassis .....	3-13
Next Steps .....	3-14
Rack Mounting Power Supplies .....	3-15
Next Steps .....	3-18
Connecting Chassis to Power Source .....	3-19
AC Power Supply Connections .....	3-19
Powering On a Chassis .....	3-19
DC Power Supply Connections .....	3-20
Connecting to a DC Power Source .....	3-20
Hot-Swapping Power Supplies .....	3-23
Hot-Swapping a Power Supply Connected to the Rear of the Chassis .....	3-23
Hot-Swapping a Rack Mounted Power Supply .....	3-24
<b>Chapter 4</b> <b>Managing Power over Ethernet (PoE)</b> .....	4-1
In This Chapter .....	4-2
Power over Ethernet Specifications .....	4-3
Viewing PoE Power Supply Status .....	4-4
Configuring Power over Ethernet Parameters .....	4-5
Power over Ethernet Defaults .....	4-5
Understanding and Modifying the Default Settings .....	4-5
Setting the PoE Operational Status .....	4-5
Configuring the Total Power Available to a Port .....	4-6
Configuring the Total Power Available to a Slot .....	4-6
Setting Port Priority Levels .....	4-7
Setting the Capacitor Detection Method .....	4-8
Understanding Priority Disconnect .....	4-9
Setting Priority Disconnect Status .....	4-9
Disabling Priority Disconnect .....	4-9
Enabling Priority Disconnect .....	4-9
Priority Disconnect is Enabled; Same Priority Level on All PD .....	4-10
Priority Disconnect is Enabled; Incoming PD Port has Highest Priority Level .....	4-10
Priority Disconnect is Enabled; Incoming PD Port has Lowest Priority Level .....	4-10
Priority Disconnect is Disabled .....	4-11
Monitoring Power over Ethernet via CLI .....	4-12
<b>Chapter 5</b> <b>Managing OmniSwitch 6400 Series Stacks</b> .....	5-1
In This Chapter .....	5-2
OmniSwitch 6400 Series Stack Overview .....	5-3
Roles Within the Stack .....	5-3

Primary and Secondary Management Modules .....	5-3
Primary Management Module Selection .....	5-6
Secondary Management Module Selection .....	5-9
Idle Module Role .....	5-11
Pass-Through Mode .....	5-12
Recovering from Pass-Through Mode (Duplicate Slot Numbers) .....	5-13
Stack Redundancy and Failover .....	5-16
Checking Redundant Stacking Cable Status .....	5-17
Slot Numbering .....	5-18
Dynamic Slot Number Assignment .....	5-19
Manual Slot Number Assignment .....	5-21
Reverting to the Dynamic Slot Numbering Model .....	5-22
Hot-Swapping Modules In a Stack .....	5-23
Removing Switches from an Existing Stack .....	5-23
Inserting Switches Into an Existing Stack .....	5-23
Merging Stacks .....	5-24
Reloading Switches .....	5-25
Reloading the Primary Management Module .....	5-25
Reloading the Secondary Management Module .....	5-27
Reloading Switches with Idle Roles .....	5-29
Reloading Switches in Pass-Through Mode .....	5-29
Reloading All Switches in a Stack .....	5-30
Software Synchronization During a Full Reload .....	5-30
Effects of Saved Slot Number Information on the Reload Process .....	5-30
Avoiding Split Stacks .....	5-32
Changing the Secondary Module to Primary .....	5-33
Synchronizing Switches in a Stack .....	5-35
Automatic Synchronization During a Full Reload .....	5-35
Monitoring the Stack .....	5-36
Visually Monitoring the Stack .....	5-36
CLI Commands Supported on Both Primary and Secondary Management Modules .....	5-37
<b>Chapter 6</b> <b>Booting OmniSwitch 6400 Series Switches</b> .....	6-1
Booting a Stand-Alone Switch .....	6-1
Booting Stacked Configurations .....	6-2
Monitoring the Chassis .....	6-3
Checking the Overall Chassis Status .....	6-3
Checking the Temperature Status .....	6-3
Checking the Fan Status .....	6-4
Checking the Power Supply Status .....	6-4
Additional Monitoring Commands .....	6-4
Using LEDs to Visually Monitor the Chassis .....	6-4
<b>Appendix A</b> <b>Regulatory Compliance and Safety Information</b> .....	A-1
Declaration of Conformity: CE Mark .....	A-1

Waste Electrical and Electronic Equipment (WEEE) Statement .....	A-1
China RoHS: Hazardous Substance Table .....	A-2
Standards Compliance .....	A-4
FCC Class A, Part 15 .....	A-5
Canada Class A Statement .....	A-5
JATE .....	A-5
CISPR22 Class A warning .....	A-6
VCCI .....	A-6
Class A Warning for Taiwan and Other Chinese Markets .....	A-6
Translated Safety Warnings .....	A-7
Chassis Lifting Warning .....	A-7
Blank Panels Warning .....	A-7
Electrical Storm Warning .....	A-7
Installation Warning .....	A-8
Invisible Laser Radiation Warning .....	A-8
Operating Voltage Warning .....	A-8
Power Disconnection Warning .....	A-9
Proper Earthing Requirement Warning .....	A-9
DC Power Supply Connection Warning .....	A-10
Read Important Safety Information Warning .....	A-10
Restricted Access Location Warning .....	A-10
Wrist Strap Warning .....	A-11
Instrucciones de seguridad en español .....	A-12
Advertencia sobre el levantamiento del chasis .....	A-12
Advertencia de las tapaderas en blanco .....	A-12
Advertencia en caso de tormenta eléctrica .....	A-12
Advertencia de instalación .....	A-12
Advertencia de radiación láser invisible .....	A-12
Advertencia de la batería de litio .....	A-12
Advertencia sobre la tensión de operación .....	A-12
Advertencia sobre la desconexión de la fuente .....	A-12
Advertencia sobre una apropiada conexión a tierra .....	A-13
Leer “información importante de seguridad” .....	A-13
Advertencia de acceso restringido .....	A-13
Advertencia de pulsera antiestática .....	A-13
Clase de seguridad .....	A-13
Advertencia de fuentes de poder .....	A-13





# About This Guide

This *OmniSwitch 6400 Series Hardware Users Guide* describes your switch hardware components and basic switch hardware procedures.

## Supported Platforms

This information in this guide applies to the following products:

- OmniSwitch 6400-24
- OmniSwitch 6400-P24
- OmniSwitch 6400-48
- OmniSwitch 6400-P48
- OmniSwitch 6400-U24
- OmniSwitch 6400 U24D

## **Unsupported Platforms**

The information in this guide does not apply to the following products:

- OmniSwitch (original version with no numeric model name)
- OmniSwitch 6600 Family
- OmniSwitch 6800 Series
- OmniSwitch 6850 Series
- OmniSwitch 6855 Series
- OmniSwitch 7700
- OmniSwitch 7800
- OmniSwitch 8800
- OmniSwitch 9000 Series
- OmniStack
- OmniAccess

## Who Should Read this Manual?

The audience for this users guide is network administrators and IT support personnel who need to configure, maintain, and monitor switches and routers in a live network. However, anyone wishing to gain knowledge on the OmniSwitch 6400 Series hardware will benefit from the material in this guide.

## When Should I Read this Manual?

Read this guide as soon as you are ready to familiarize yourself with your switch hardware components. You should have already stepped through the first login procedures and read the brief hardware overviews in the *OmniSwitch 6400 Series Getting Started Guide*.

You should already be familiar with the very basics of the switch hardware, such as module LEDs and module installation procedures. This manual will help you understand your switch hardware components (e.g., chassis, stacking and cables, backup power supplies, etc.) in greater depth.

## What is in this Manual?

This users guide includes the following hardware-related information:

- Descriptions of switch configurations.
- Descriptions of “availability” features.
- Descriptions of chassis types (e.g., the OS6400-24).
- Instructions for mounting the chassis.
- Descriptions of hardware components (status LEDs, chassis, cables, backup power supplies, etc.).
- Managing a chassis.
- Hardware-related Command Line Interface (CLI) commands

## What is Not in this Manual?

The descriptive and procedural information in this manual focuses on switch hardware. It includes information on some CLI commands that pertain directly to hardware configuration, but it is not intended as a software users guide. There are several OmniSwitch 6400 Series users guides that focus on switch software configuration. Consult those guides for detailed information and examples for configuring your switch software to operate in a live network environment. See [“Documentation Roadmap” on page -xii](#) and [“Related Documentation” on page -xiv](#) for further information on software configuration guides available for your switch.

# How is the Information Organized?

This users guide provides an overview of OmniSwitch 6400 Series switches, specifications of the hardware components, steps for setting up and managing OmniSwitch 6400 Series switches, and an overview and procedures for managing Power over Ethernet (PoE).

## Documentation Roadmap

The OmniSwitch user documentation suite was designed to supply you with information at several critical junctures of the configuration process. The following section outlines a roadmap of the manuals that will help you at each stage of the configuration process. Under each stage, we point you to the manual or manuals that will be most helpful to you.

### Stage 1: Using the Switch for the First Time

**Pertinent Documentation:** *Getting Started Guide*  
*Release Notes*

The *Getting Started Guide* provides all the information you need to get your switch up and running the first time. This guide provides information on unpacking the switch, installing power supplies, unlocking access control, setting the switch's IP address, and setting up a password. It also includes succinct overview information on fundamental aspects of the switch, such as hardware LEDs, the software directory structure, stacking, CLI conventions, and web-based management.

At this time you should also familiarize yourself with the Release Notes that accompanied your switch. This document includes important information on feature limitations that are not included in other user guides.

### Stage 2: Gaining Familiarity with Basic Switch Functions

**Pertinent Documentation:** *Hardware Users Guide*  
*Switch Management Guide*

Once you have your switch up and running, you will want to begin investigating basic aspects of its hardware and software. Information about switch hardware is provided in the *Hardware Users Guide*. This guide provide specifications, illustrations, and descriptions of all hardware components—e.g., chassis, backup power supplies, etc.

The *Switch Management Guide* is the primary user guide for the basic software features on a switch. This guide contains information on the switch directory structure, basic file and directory utilities, switch access security, SNMP, and web-based management. It is recommended that you read this guide before connecting your switch to the network.

## **Stage 3: Integrating the Switch Into a Network**

**Pertinent Documentation:** *Network Configuration Guide*  
*Advanced Routing Configuration Guide*

When you are ready to connect your switch to the network, you will need to learn how the OmniSwitch implements fundamental software features, such as 802.1Q, VLANs, and Spanning Tree. The *Network Configuration Guide* contains overview information, procedures and examples on how standard networking technologies are configured on the OmniSwitch 6400 Series.

The *Advanced Routing Configuration Guide* includes configuration information for networks using advanced routing technologies (OSPF and BGP) and multicast routing protocols (DVMRP and PIM-SM).

### **Anytime**

The *OmniSwitch CLI Reference Guide* contains comprehensive information on all CLI commands supported by the switch. This guide includes syntax, default, usage, example, related CLI command, and CLI-to-MIB variable mapping information for all CLI commands supported by the switch. This guide can be consulted anytime during the configuration process to find detailed and specific information on each CLI command.

## Related Documentation

The following are the titles and descriptions of all the OmniSwitch 6400 Series user manuals:

- *OmniSwitch 6400 Series Getting Started Guide*

Describes the hardware and software procedures for getting an OmniSwitch 6400 Series switch up and running. Also provides information on fundamental aspects of OmniSwitch software.
- *OmniSwitch 6400 Series Hardware Users Guide*

Detailed technical specifications and procedures for the OmniSwitch 6400 Series chassis and components. This manual also includes comprehensive information on assembling and managing stacked configurations.
- *OmniSwitch AOS Release 6 CLI Reference Guide*

Complete reference to all CLI commands supported on the OmniSwitch 6400, 6850E, 6855, and 9000. Includes syntax definitions, default values, examples, usage guidelines and CLI-to-MIB variable mappings.
- *OmniSwitch AOS Release 6 Switch Management Guide*

Includes procedures for readying an individual switch for integration into a network. Topics include the software directory architecture, image rollback protections, authenticated switch access, managing switch files, system configuration, using SNMP, and using web management software (WebView).
- *OmniSwitch AOS Release 6 Network Configuration Guide*

Includes network configuration procedures and descriptive information on all the major software features and protocols included in the base software package. Chapters cover Layer 2 information (Ethernet and VLAN configuration), Layer 3 information (routing protocols, such as RIP), security options (authenticated VLANs), Quality of Service (QoS), and link aggregation.
- *OmniSwitch AOS Release 6 Advanced Routing Configuration Guide*

Includes network configuration procedures and descriptive information on all the software features and protocols included in the advanced routing software package. Chapters cover multicast routing (DVMRP and PIM-SM), and OSPF.
- *OmniSwitch AOS Release 6 Transceivers Guide*

Includes SFP and XFP transceiver specifications and product compatibility information.
- *Technical Tips, Field Notices*

Includes information published by Alcatel-Lucent's Customer Support group.
- *Release Notes*

Includes critical Open Problem Re, feature exceptions, and other important information on the features supported in the current release and any limitations to their support.

## Published / Latest Product Documentation

All user guides for the OmniSwitch 6400 Series are included on the Alcatel-Lucent public website. This website also includes user guides for other Alcatel-Lucent Enterprise products.

The latest user guides can be found on our website at:

<http://enterprise.alcatel-lucent.com/?dept=UserGuides&page=Portal>

---

## Technical Support

An Alcatel-Lucent service agreement brings your company the assurance of 7x24 no-excuses technical support. You'll also receive regular software updates to maintain and maximize your Alcatel-Lucent product's features and functionality and on-site hardware replacement through our global network of highly qualified service delivery partners. Additionally, with 24-hour-a-day access to Alcatel-Lucent's Service and Support web page, you'll be able to view and update any case (open or closed) that you have reported to Alcatel-Lucent's technical support, open a new case or access helpful release notes, technical bulletins, and manuals. For more information on Alcatel-Lucent's Service Programs, see our web page at [service.esd.alcatel-lucent.com](http://service.esd.alcatel-lucent.com), call us at 1-800-995-2696, or email us at [esd.support@alcatel-lucent.com](mailto:esd.support@alcatel-lucent.com).





# 1 OmniSwitch 6400 Series

The OmniSwitch 6400 Series (OS6400) is a series of fixed configuration stackable Gigabit Ethernet switches with advanced Layer 2 and basic routing capabilities. Application examples include the Enterprise edge, the SMB core, as metro access CPE devices, etc.

OS6400 switches are available in 24 port copper and fiber configurations, as well as 48 port copper configurations. Power over Ethernet (PoE), DC power, Backup Power Supply (BPS) are also offered. Refer to [“OmniSwitch 6400 Series Chassis Configurations”](#) on page 1-2 for additional details.

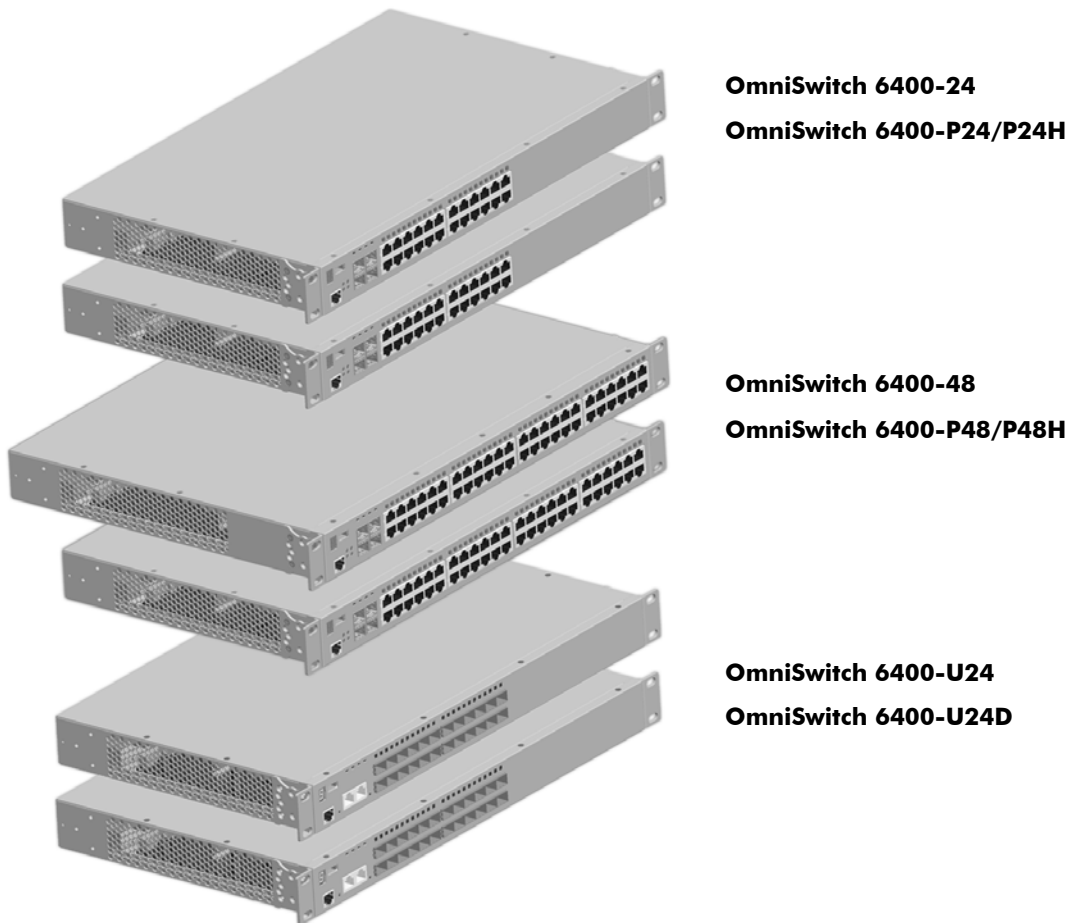

# OmniSwitch 6400 Series Chassis Configurations

## OmniSwitch 6400-24

The OmniSwitch 6400-24 (OS6400-24) is a 24-port fixed stackable chassis with 20 RJ-45 ports configurable to 10/100/1000, four (4) combo SFP/RJ45 ports, and two (2) 10 Gigabit Ethernet stacking ports. The OS6400-24 contains one internal AC power supply, an external AC or DC Backup Power Supply (BPS) is also available.

## OmniSwitch 6400-48

The OmniSwitch 6400-48 (OS6400-48) is a 48-port fixed stackable chassis with 44 RJ-45 ports configurable to 10/100/1000, four (4) combo SFP/RJ45 ports, and two (2) 10 Gigabit Ethernet stacking ports. The OS6400-48 contains one internal AC power supply, an external AC or DC Backup Power Supply (BPS) is also available.

## OmniSwitch 6400-P24

The OmniSwitch 6400-P24 (OS6400-P24) is a 24-port Power over Ethernet (PoE) capable stackable chassis with 20 RJ-45 ports configurable to 10/100/1000, four (4) combo SFP/RJ45 ports, and two (2) 10 Gigabit Ethernet stacking ports. The OS6400-P24 supports two external 360W power supplies.

## OmniSwitch 6400-P48

The OmniSwitch 6400-P48 (OS6400-P48) is a 48-port Power over Ethernet (PoE) capable stackable chassis with 44 RJ-45 ports configurable to 10/100/1000, four (4) combo SFP/RJ45 ports, and two (2) 10 Gigabit Ethernet stacking ports. The OS6400-P48 supports two external 360W power supplies.

## OmniSwitch 6400-P24H

The OmniSwitch 6400-P24H (OS6400-P24H) is a 24-port Power over Ethernet (PoE) capable stackable chassis with 20 RJ-45 ports configurable to 10/100/1000, four (4) combo SFP/RJ45 ports, and two (2) 10 Gigabit Ethernet stacking ports. The OS6400-P24H supports two external 510W power supplies.

## OmniSwitch 6400-P48H

The OmniSwitch 6400-P48H (OS6400-P48H) is a 48-port Power over Ethernet (PoE) capable stackable chassis with 44 RJ-45 ports configurable to 10/100/1000, four (4) combo SFP/RJ45 ports, and two (2) 10 Gigabit Ethernet stacking ports. The OS6400-P48H supports two external 510W power supplies.

## OmniSwitch 6400-U24

The OmniSwitch 6400-U24 (OS6400-U24) is a 24-port AC powered fixed stackable chassis with 22 SFP fiber ports (100 or 1000BaseX), two (2) combo SFP/RJ45 ports, and two (2) 10 Gigabit Ethernet stacking ports. The OS6400-U24 contains one internal AC power supply, an external AC or DC Backup Power Supply (BPS) is also available.

## OmniSwitch 6400-U24D

The OmniSwitch 6400-U24D (OS6400-U24D) is a 24-port DC powered fixed stackable chassis with 22 SFP fiber ports (100 or 1000BaseX), two (2) combo SFP/RJ45 ports, and two (2) 10 Gigabit Ethernet stacking ports. The OS6400-U24D contains one internal DC power supply, an external AC or DC Backup Power Supply (BPS) is also available.

# Availability Features

The switch provides a broad variety of *availability* features. Availability features are hardware and software-based safeguards that help to prevent the loss of data flow in the unlikely event of a subsystem failure. In addition, some availability features allow users to maintain or replace hardware components without powering off the switch or interrupting switch operations. Combined, these features provide added resiliency and help to ensure that the switch or virtual chassis is consistently available for day-to-day network operations.

Hardware-related availability features include:

- [Software Rollback](#)
- [Backup Power Supplies](#)
- [Hot Swapping](#)
- [Hardware Monitoring](#)

## Software Rollback

Software rollback (also referred to as *image rollback*) essentially allows the OmniSwitch 6400 Series switches to return to a prior “last known good” version of software in the event of a system software problem. The switch controls software rollback through its resilient directory structure design (i.e., `/flash/working` and `/flash/certified`).

For detailed information on the software rollback feature, as well as the switch’s `/flash/working` and `/flash/certified` directories, refer to the “Managing CMM Directory Content” chapter in the *OmniSwitch Switch Management Guide*.

## Backup Power Supplies

The OmniSwitch 6400 Series switches support an optional backup power supply. This power supply is connected to the rear of the unit. There is a power shelf provided with the unit that slides into the rear of the chassis and is used to hold the power supplies. It can hold 510W or 360W power supply or in case of non-PoE product switches 120W or 126W power supply. This provides redundant chassis power on a 1:1 basis.

Backup power supplies operate in active standby mode. If the primary power supply fails unexpectedly, the backup power supply automatically takes up the full power load without disrupting the switch.

---

**Note.** For more information on backup power supplies, refer to [Chapter 2, “OmniSwitch 6400 Series Chassis and Hardware Components.”](#)

---

## Hot Swapping

Hot swapping refers to the action of adding, removing, or replacing components without powering off switches or disrupting other components. This feature facilitates hardware upgrades and maintenance and allows users to easily replace components in the unlikely event of hardware failure.

The following hardware components can be hot swapped:

- Backup power supply
- Backup power supply connector cables
- SFPs

For instructions on hot swapping backup power supplies, refer to [Chapter 3, “Mounting OS6400 Switches.”](#) For instructions on hot swapping combo connector SFPs, refer to the *OmniSwitch Transceivers Guide*.

## Hardware Monitoring

### Automatic Monitoring

Automatic monitoring refers to the switch’s built-in sensors that automatically monitor operations. If an error is detected (e.g., over-threshold temperature), the switch immediately sends a trap to the user. The trap is displayed on the console in the form of a text error message. (In the case of an over-threshold temperature condition, the chassis displays an amber TMP LED in addition to sending a trap.)

### LEDs

LEDs, which provide visual status information, are provided on the chassis front panel. LEDs are used to indicate conditions such as hardware and software status, temperature errors, link integrity, data flow, etc. For detailed LED descriptions, refer to [Chapter 2, “OmniSwitch 6400 Series Chassis and Hardware Components.”](#)

### User-Driven Monitoring

User-driven hardware monitoring refers to CLI commands that are entered by the user in order to access the current status of hardware components. The user enters “show” commands that output information to the console. Monitoring information for chassis components, such as the optional back up power supply, chassis temperature sensor, and chassis fans is provided in [Chapter 2, “OmniSwitch 6400 Series Chassis and Hardware Components.”](#) The show commands for all the features are described in detail in the *OmniSwitch CLI Reference Guide*.

# 2 OmniSwitch 6400 Series Chassis and Hardware Components



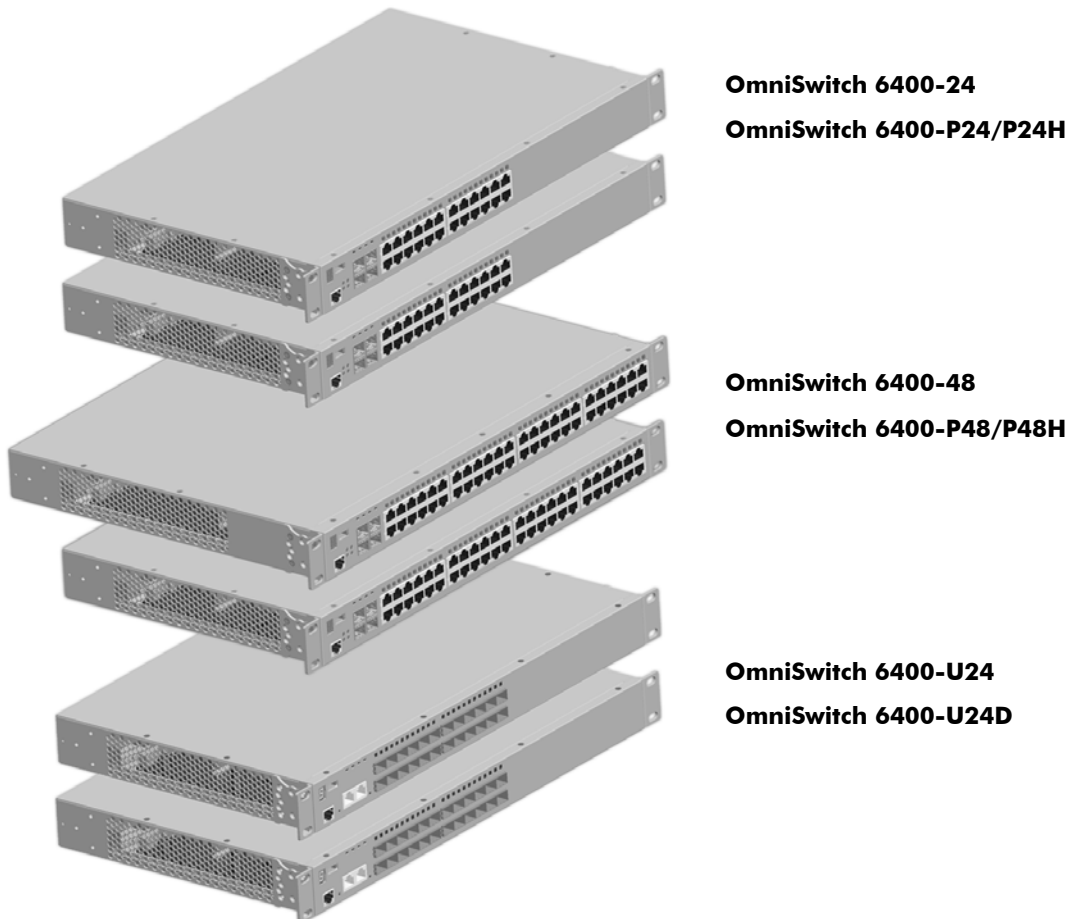



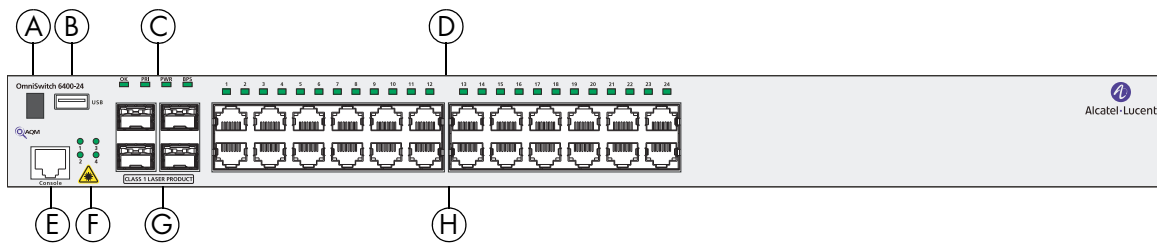

## OmniSwitch 6400 Series Chassis Configurations



## OmniSwitch 6400-24 Front Panel



OS6400-24 Front Panel

Item	Description	
A	<b>LED Indicator</b> Seven segment LED provides stack element ID.	
B	<b>USB Port</b> High speed USB 2.0 port.	
C	<b>System Status LEDs</b> Provides status on hardware, software, primary and redundant power. Refer to <a href="#">“LED Status Indicators” on page 2-20</a> for LED status information.	
D	<b>10/100/1000BaseT RJ-45 Port LEDs</b> Provides link and traffic status. Refer to <a href="#">“LED Status Indicators” on page 2-20</a> for LED status information.	
E	<b>Console Port</b> RS-232 console port with an RJ-45 connector. Provides access to the CLI for configuration and management.	
F	<b>SFP Combo Port LEDs</b> Provides link and traffic status for SFP transceivers. Refer to <a href="#">“LED Status Indicators” on page 2-20</a> for LED status information.	
G	<b>SFP Combo Ports</b> Four combo (1-4) SFP connectors for various supported SFP transceivers. Odd-numbered ports are on top row, even-numbered ports are on bottom row.	
H	<b>10/100/1000BaseT RJ-45 Ports</b> Twenty 10/100/1000BaseT non-combo (5–24) and four 10/100/1000BaseT combo (1–4) ports. Odd-numbered ports are on top row, even-numbered ports are on bottom row.	

## OmniSwitch 6400-24 Rear Panel

**Note.** The figure shows a pre-production version of the chassis without product, safety, and compliance information labels. All production versions of the chassis have these labels.

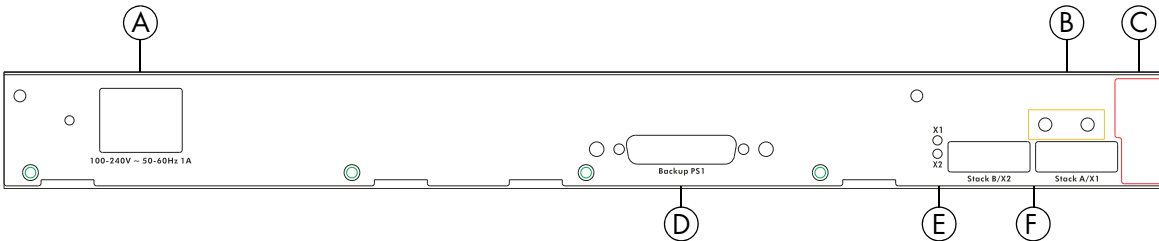

OS6400-24 Rear Panel

Item	Description
<b>A</b>	<b>Power Supply Connector</b> Internal 126W AC power supply.
<b>B</b>	<b>Grounding Block</b> Type LCD8-10A-L grounding lug
<b>C</b>	Fan Tray filter
<b>D</b>	<b>Redundant Power Supply Connector</b> DB-25 connector for optional external redundant power supply.
<b>E</b>	<b>Stacking/Uplink LEDs</b> Provides link or traffic status for stacking/uplink connectors. Refer to <a href="#">“LED Status Indicators”</a> on page 2-20 for LED status information.
<b>F</b>	<b>Stacking/Uplink Connectors</b> Connectors for use in stacking switches into a virtual chassis or as an uplink port.

---

## OS6400-24 Specifications

---

Total non-combo 10/100/1000Base-T ports per switch (5–24)	20
Total combo 10/100/1000Base-T combo ports per switch (1–4)	4
Total combo SFP connectors per switch (1–4)	4
Total 10/100/1000Base-T ports per stack	192 (stack of eight switches)
Total SFP connectors per stack	32 (stack of eight switches)
Power	Primary (Internal): 126W AC Redundant (External): 126W AC or 120W DC
Flash memory size	128 MB
RAM memory size	256 MB SDRAM
Width	17.32 in. (44.0 cm)
Height	1.73 in. (4.4 cm)
Height (rack units)	1 RU
Depth	17.75 in. (45.09 cm) (with external power supply) 10.75 in. (27.31 cm) (without external power supply)
Weight	9.43 lbs.(4.28 kg)
Relative Humidity	Operating: 5% to 95% (non-condensing) Storage: 5% to 95% (non-condensing)
Ambient Temperature	Operating: 32° F to 113° F (0 °C to 45 °C) Storage: 14° F to 158° F (-10 °C to 70 °C)
Altitude	Operating: Up to 10,000 ft. (3048 m) Storage: Up to 40,000 ft. (12192 m)
Maximum frame size	9216 bytes
Ethernet standards	802.3i (10BaseT), Cable: (Cat 5 UTP) 802.3u (100BaseTX), Cable: (Cat 5e/6 UTP, EIA/TIA 568) 802.3ab (1000Base-T), Cable: (Cat -5e/6, UTP, EIA/TIA 568) 802.3z (1000Base-X), Cable: (SMF, MMF) 802.3ah (EFM), Cable: (SMF, MMF)
Maximum cable distance (RJ-45)	100 meters







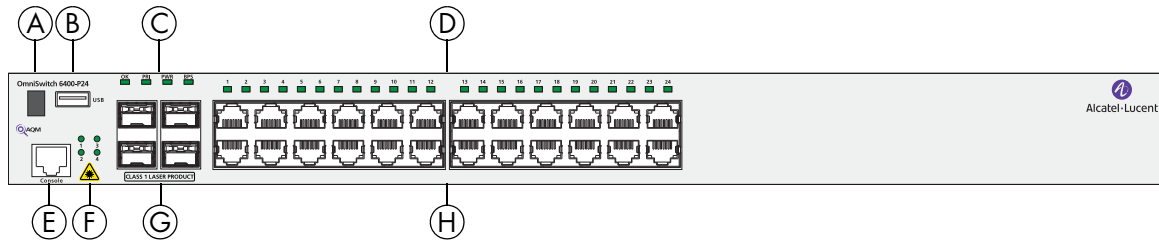

---



## OmniSwitch 6400-P24 Front Panel

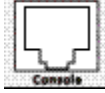

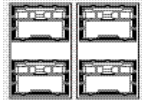
OS6400-P24 Front Panel

Item	Description	
A	<b>LED Indicator</b> Seven segment LED provides stack element ID.	
B	<b>USB Port</b> High speed USB 2.0 port.	
C	<b>System Status LEDs</b> Provides status on hardware, software, primary and redundant power. Refer to <a href="#">“LED Status Indicators” on page 2-20</a> for LED status information.	
D	<b>10/100/1000BaseT RJ-45 Power Over Ethernet Port LEDs</b> Provides link and traffic status. Refer to <a href="#">“LED Status Indicators” on page 2-20</a> for LED status information.	
E	<b>Console Port</b> RS-232 console port with an RJ-45 connector. Provides access to the CLI for configuration and management.	
F	<b>SFP Combo Port LEDs</b> Provides link and traffic status for SFP transceivers. Refer to <a href="#">“LED Status Indicators” on page 2-20</a> for LED status information.	
G	<b>SFP Combo Ports</b> Four combo (1-4) SFP connectors for various supported SFP transceivers. Odd-numbered ports are on top row, even-numbered ports are on bottom row.	
H	<b>10/100/1000BaseT RJ-45 Power Over Ethernet Ports</b> Twenty 10/100/1000BaseT non-combo (5–24) and four 10/100/1000BaseT combo (1–4) PoE ports. Odd-numbered ports are on top row, even-numbered ports are on bottom row.	

## OmniSwitch 6400-P24 Rear Panel

**Note.** The figure shows a pre-production version of the chassis without product, safety, and compliance information labels. All production versions of the chassis have these labels.

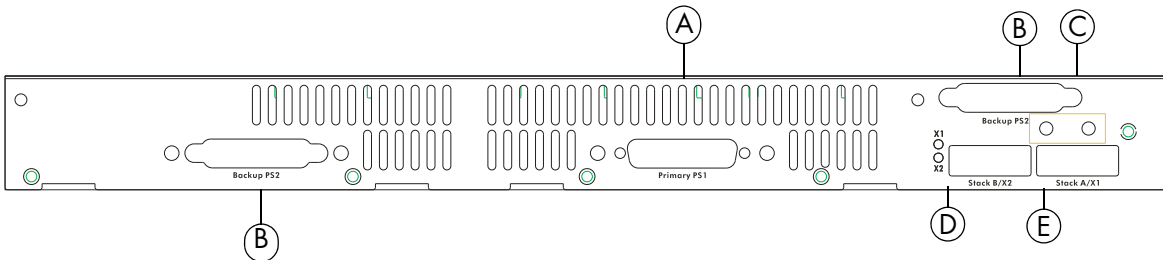

OS6400-P24 Rear Panel

Item	Description
A	<b>Primary PS1 Power Supply Connector</b> DB-25 connector for required external primary power supply.
B	<b>Redundant PS2 Power Supply Connector</b> DB-25 connector for optional external redundant power supply.
C	<b>Grounding Block</b> Type LCD8-10A-L grounding lug
D	<b>Stacking/Uplink LEDs</b> Provides link or traffic status for stacking/uplink connectors. Refer to <a href="#">“LED Status Indicators”</a> on page 2-20 for LED status information.
E	<b>Stacking/Uplink Connectors</b> Connectors for use in stacking switches into a virtual chassis or as an uplink port

**Note .** The rear panel of the OS6400-P24 contains three DB-25 power supply connectors for connecting external 360W and 510W power supplies. One of the connectors is labeled 'Primary PS1' and two of the connectors are labeled 'Backup PS2'. The primary power supply must be connected to the 'Primary PS1' connector. A redundant power supply can be connected to either of the 'Backup PS2' connectors.

---

## OS6400-P24 Specifications

---





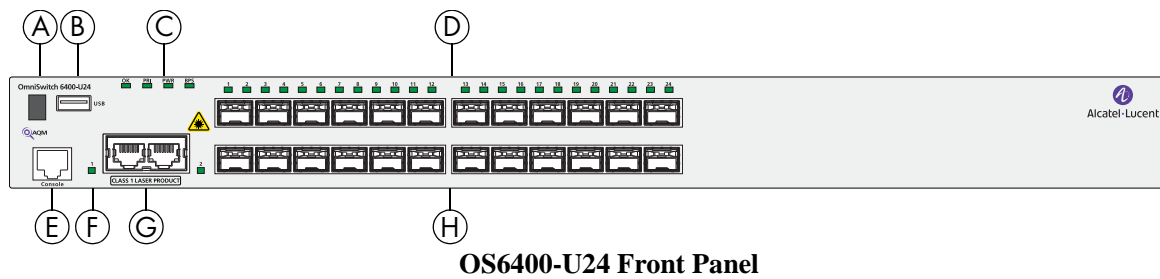

Total non-combo 10/100/1000 Base-T PoE ports per switch (5–24)	20
Total combo 10/100/1000 Base-T PoE ports per switch (1–4)	4
Total combo SFP connectors per switch (1–4)	4
Total 10/100/1000 Base-T PoE per stack	192 (stack of eight switches)
Total combo SFP connectors per stack	32 (stack of eight switches)
Power	Primary (External): 360W AC or 510W AC Redundant (External): 360W AC or 510W AC
Flash memory size	128 MB
RAM memory size	256 MB SDRAM
Width	17.32 in. (44.0 cm)
Height	1.73 in. (4.4 cm)
Height (rack units)	1 RU
Depth	17.75 in. (45.09 cm) (with external power supply) 10.75 in. (27.31 cm) (without external power supply)
Weight	8.97 lbs. (4.07 kg)
Relative Humidity	Operating: 5% to 95% (non-condensing) Storage: 5% to 95% (non-condensing)
Ambient Temperature	Operating: 32° F to 113° F (0 °C to 45 °C) Storage: 14° F to 158° F (-10 °C to 70 °C)
Altitude	Operating: Up to 10,000 ft. (3048 m) Storage: Up to 40,000 ft. (12192 m)
Maximum frame size	9216 bytes
Ethernet standards	802.3i (10BaseT), Cable: (Cat 5 UTP) 802.3u (100BaseTX), Cable: (Cat 5e/6 UTP, EIA/TIA 568) 802.3ab (1000Base-T), Cable: (Cat -5e/6, UTP, EIA/TIA 568) 802.3z (1000Base-X), Cable: (SMF, MMF) 802.3ah (EFM), Cable: (SMF, MMF)
Maximum cable distance (RJ-45)	100 meters

---

## OmniSwitch 6400-U24 Front Panel

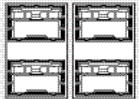

OS6400-U24 Front Panel

Item	Description	
A	<b>LED Indicator</b> Seven segment LED provides stack element ID.	
B	<b>USB Port</b> High speed USB 2.0 port.	
C	<b>System Status LEDs</b> Provides status on hardware, software, primary and redundant power. Refer to <a href="#">“LED Status Indicators”</a> on page 2-20 for LED status information.	
D	<b>SFP LEDs</b> Provides link and traffic status. Refer to <a href="#">“LED Status Indicators”</a> on page 2-20 for LED status information.	
E	<b>Console Port</b> RS-232 console port with an RJ-45 connector. Provides access to the CLI for configuration and management.	
F	<b>10/100/1000BaseT RJ-45 Combo Port LEDs</b> Provides link and traffic status. Refer to <a href="#">“LED Status Indicators”</a> on page 2-20 for LED status information.	
G	<b>10/100/1000BaseT RJ-45 Combo Ports</b> Two 10/100/1000BaseT RJ-45 combo ports (1–2).	
H	<b>SFP Connectors</b> Twenty-two non-combo SFP connectors (3-24) and two combo SFP connectors (1-2) for various supported SFP transceivers. Odd-numbered ports are on top row, even-numbered ports are on bottom row.	

## OmniSwitch 6400-U24 Rear Panel

**Note.** The figure shows a pre-production version of the chassis without product, safety, and compliance information labels. All production versions of the chassis have these labels.

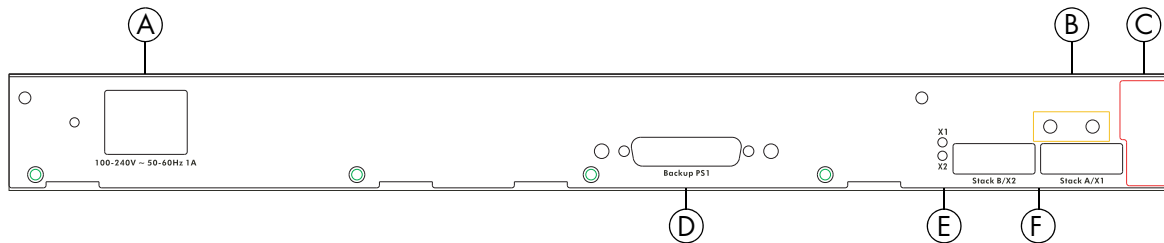

### OS6400-U24 Rear Panel

Item	Description
<b>A</b>	<b>Power Supply Connector</b> Internal 126W AC power supply.
<b>B</b>	<b>Grounding Block</b> Type LCD8-10A-L grounding lug
<b>C</b>	Fan Tray filter
<b>D</b>	<b>Redundant Power Supply Connector</b> DB-25 connector for optional external redundant power supply.
<b>E</b>	<b>Stacking/Uplink LEDs</b> Provides link or traffic status for stacking/uplink connectors. Refer to <a href="#">“LED Status Indicators”</a> on page 2-20 for LED status information.
<b>F</b>	<b>Stacking/Uplink Connectors</b> Connectors for use in stacking switches into a virtual chassis or as an uplink port.

---

## OS6400-U24 Specifications

---





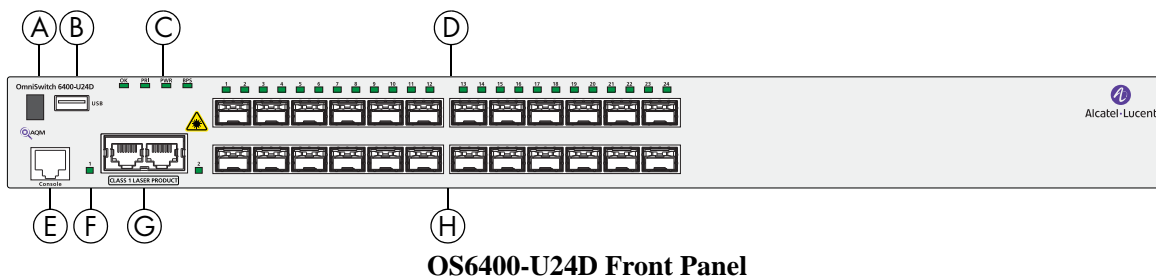

Total non-combo SFP connectors per switch (3–24)	22
Total combo SFP connectors per switch (1–2)	2
Total combo 10/100/1000 Base-T ports per switch (1–2)	2
Total SFP connectors per stack	192 (stack of eight switches)
Total 10/100/1000 Base-T ports per stack	16 (stack of eight switches)
Power	Primary (Internal): 126W AC Redundant (External): 126W AC or 120W DC
Flash memory size	128 MB
RAM memory size	256 MB SDRAM
Width	17.32 in. (44.0 cm)
Height	1.73 in. (4.4 cm)
Height (rack units)	1 RU
Depth	17.75 in. (45.09 cm) (with external power supply) 10.75 in. (27.31 cm) (without external power supply)
Weight	9.76 lbs. (4.43 kg)
Relative Humidity	Operating: 5% to 95% (non-condensing) Storage: 5% to 95% (non-condensing)
Ambient Temperature	Operating: 32° F to 113° F (0 °C to 45 °C) Storage: 14° F to 158° F (-10 °C to 70 °C)
Altitude	Operating: Up to 10,000 ft. (3048 m) Storage: Up to 40,000 ft. (12192 m)
Maximum frame size	9216 bytes
Ethernet standards	802.3i (10BaseT), Cable: (Cat 5 UTP) 802.3u (100BaseTX), Cable: (Cat 5e/6 UTP, EIA/TIA 568) 802.3ab (1000Base-T), Cable: (Cat -5e/6, UTP, EIA/TIA 568) 802.3z (1000Base-X), Cable: (SMF, MMF) 802.3ah (EFM), Cable: (SMF, MMF)
Maximum cable distance (RJ-45)	100 meters

---

## OmniSwitch 6400-U24D Front Panel

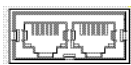
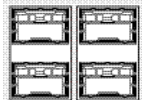

OS6400-U24D Front Panel

Item	Description	
A	<b>LED Indicator</b> Seven segment LED provides stack element ID.	
B	<b>USB Port</b> High speed USB 2.0 port.	
C	<b>System Status LEDs</b> Provides status on hardware, software, primary and redundant power. Refer to <a href="#">“LED Status Indicators”</a> on page 2-20 for LED status information.	
D	<b>SFP LEDs</b> Provides link and traffic status. Refer to <a href="#">“LED Status Indicators”</a> on page 2-20 for LED status information.	
E	<b>Console Port</b> RS-232 console port with an RJ-45 connector. Provides access to the CLI for configuration and management.	
F	<b>10/100/1000BaseT RJ-45 Combo Port LEDs</b> Provides link and traffic status. Refer to <a href="#">“LED Status Indicators”</a> on page 2-20 for LED status information.	
G	<b>10/100/1000BaseT RJ-45 Combo Ports</b> Two 10/100/1000BaseT RJ-45 combo ports (1–2).	
H	<b>SFP Connectors</b> Twenty-two non-combo SFP connectors (3-24) and two combo SFP connectors (1-2) for various supported SFP transceivers. Odd-numbered ports are on top row, even-numbered ports are on bottom row.	

## OmniSwitch 6400-U24D Rear Panel

**Note.** The figure shows a pre-production version of the chassis without product, safety, and compliance information labels. All production versions of the chassis have these labels.

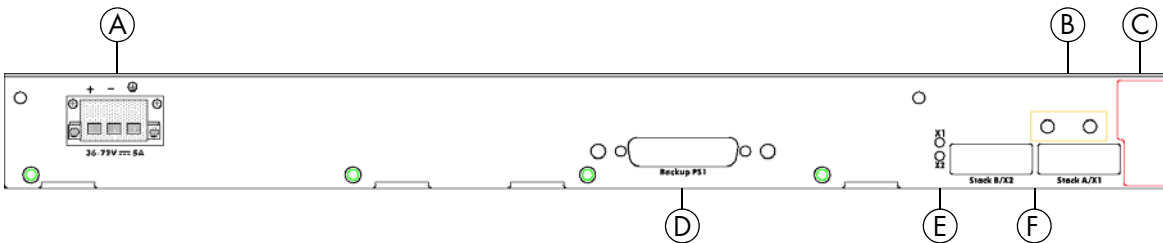

OS6400-U24D Rear Panel

Item	Description
A	<b>Power Supply Connector</b> Internal 120W DC power supply.
B	<b>Grounding Block</b> Type LCD8-10A-L grounding lug
C	Fan Tray filter
D	<b>Redundant Power Supply Connector</b> DB-25 connector for optional external redundant power supply.
E	<b>Stacking/Uplink LEDs</b> Provides link or traffic status for stacking/uplink connectors. Refer to <a href="#">“LED Status Indicators”</a> on page 2-20 for LED status information.
F	<b>Stacking/Uplink Connectors</b> Connectors for use in stacking switches into a virtual chassis or as an uplink port.



---

## OS6400-U24D Specifications

---







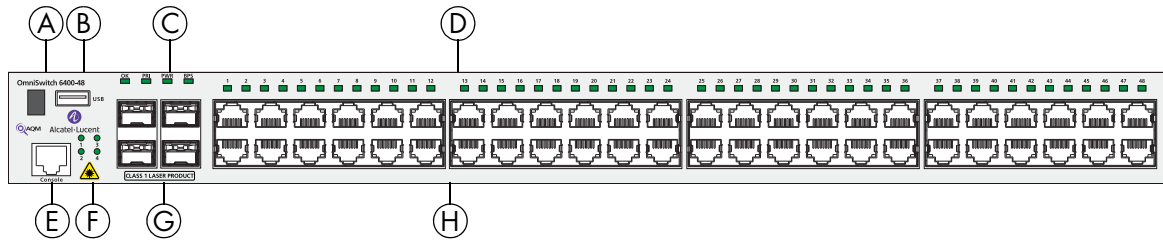

Total non-combo SFP connectors per switch (3–24)	22
Total combo SFP connectors per switch (1–2)	2
Total combo 10/100/1000Base-T ports per switch (1–2)	2
Total SFP connectors per stack	192 (stack of eight switches)
Total 10/100/1000Base-T ports per stack	16 (stack of eight switches)
Power	Primary (Internal): 120W DC Redundant (External): 120W DC or 126W AC
Flash memory size	128 MB
RAM memory size	256 MB SDRAM
Width	17.32 in. (44.0 cm)
Height	1.73 in. (4.4 cm)
Height (rack units)	1 RU
Depth	17.75 in. (45.09 cm) (with external power supply) 10.75 in. (27.31 cm) (without external power supply)
Weight	9.23 lbs. (4.19 kg)
Relative Humidity	Operating: 5% to 95% (non-condensing) Storage: 5% to 95% (non-condensing)
Ambient Temperature	Operating: 32° F to 113° F (0 °C to 45 °C) Storage: 14° F to 158° F (-10 °C to 70 °C)
Altitude	Operating: Up to 10,000 ft. (3048 m) Storage: Up to 40,000 ft. (12192 m)
Maximum frame size	9216 bytes
Ethernet standards	802.3i (10BaseT), Cable: (Cat 5 UTP) 802.3u (100BaseTX), Cable: (Cat 5e/6 UTP, EIA/TIA 568) 802.3ab (1000Base-T), Cable: (Cat -5e/6, UTP, EIA/TIA 568) 802.3z (1000Base-X), Cable: (SMF, MMF) 802.3ah (EFM), Cable: (SMF, MMF)
Maximum cable distance (RJ-45)	100 meters

---

# OmniSwitch 6400-48 Front Panel

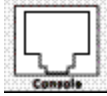

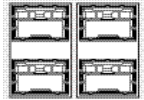
OS6400-48 Front Panel

Item	Description
A	<p><b>LED Indicator</b> Seven segment LED provides stack element ID.</p> 
B	<p><b>USB Port</b> High speed USB 2.0 port.</p> 
C	<p><b>System Status LEDs</b> Provides status on hardware, software, primary and redundant power. Refer to <a href="#">“LED Status Indicators” on page 2-20</a> for LED status information.</p> 
D	<p><b>10/100/1000BaseT RJ-45 Port LEDs</b> Provides link and traffic status. Refer to <a href="#">“LED Status Indicators” on page 2-20</a> for LED status information.</p> 
E	<p><b>Console Port</b> RS-232 console port with an RJ-45 connector. Provides access to the CLI for configuration and management.</p> 
F	<p><b>SFP Combo Port LEDs</b> Provides link and traffic status. Refer to <a href="#">“LED Status Indicators” on page 2-20</a> for LED status information.</p> 
G	<p><b>SFP Combo Ports</b> Four combo (1-4) SFP connectors for various supported SFP transceivers. Odd-numbered ports are on top row, even-numbered ports are on bottom row.</p> 
H	<p><b>10/100/1000BaseT RJ-45 Ports</b> Forty-four 10/100/1000 BaseT non-combo (5–48) and four 10/100/1000 BaseT combo (1–4) ports. Odd-numbered ports are on top row, even-numbered ports are on bottom row.</p> 

## OmniSwitch 6400-48 Rear Panel

**Note.** The figure shows a pre-production version of the chassis without product, safety, and compliance information labels. All production versions of the chassis have these labels.

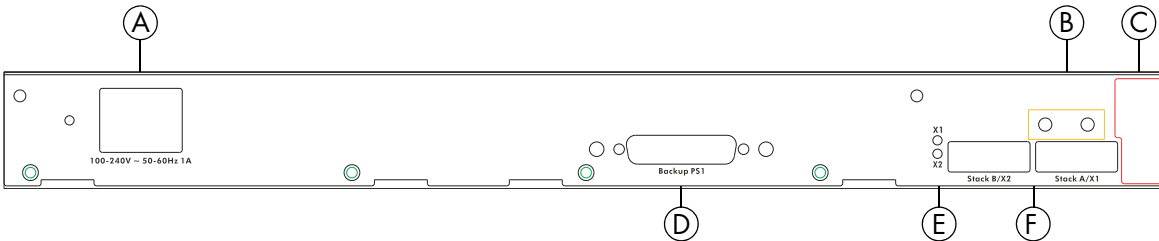

OS6400-48 Rear Panel

Item	Description
<b>A</b>	<b>Power Supply Connector</b> Internal 126W AC power supply.
<b>B</b>	<b>Grounding Block</b> Type LCD8-10A-L grounding lug
<b>C</b>	Fan Tray filter
<b>D</b>	<b>Redundant PS2 Power Supply Connector</b> DB-25 connector for optional external redundant power supply.
<b>E</b>	<b>Stacking/Uplink LEDs</b> Provides link or traffic status for stacking/uplink connectors. Refer to <a href="#">“LED Status Indicators”</a> on page 2-20 for LED status information.
<b>F</b>	<b>Stacking/Uplink Connectors</b> Connectors for use in stacking switches into a virtual chassis or as an uplink port.

---

## OS6400-48 Specifications

---



Total non-combo 10/100/1000 Base-T ports per switch (5–48)	44
Total combo 10/100/1000Base-T combo ports per switch (1–4)	4
Total combo SFP connectors per switch (1–4)	4
Total 10/100/1000 Base-T ports per stack	384 (stack of eight switches)
Total SFP connectors per stack	32 (stack of eight switches)
Power	Primary (Internal): 126W AC Redundant (External): 126W AC or 120W DC
Flash memory size	128 MB
RAM memory size	256 MB SDRAM
Width	17.32 in. (44.0 cm)
Height	1.73 in. (4.4 cm)
Height (rack units)	1 RU
Depth	20.25 in. (51.43 cm) (with external power supply) 13.25 in. (33.67 cm) (without external power supply)
Weight	11.97 lbs. (5.43 kg)
Relative Humidity	Operating: 5% to 95% (non-condensing) Storage: 5% to 95% (non-condensing)
Ambient Temperature	Operating: 32° F to 113° F (0 °C to 45 °C) Storage: 14° F to 158° F (-10 °C to 70 °C)
Altitude	Operating: Up to 10,000 ft. (3048 m) Storage: Up to 40,000 ft. (12192 m)
Maximum frame size	9216 bytes
Ethernet standards	802.3i (10BaseT), Cable: (Cat 5 UTP) 802.3u (100BaseTX), Cable: (Cat 5e/6 UTP, EIA/TIA 568) 802.3ab (1000Base-T), Cable: (Cat -5e/6, UTP, EIA/TIA 568) 802.3z (1000Base-X), Cable: (SMF, MMF) 802.3ah (EFM), Cable: (SMF, MMF)
Maximum cable distance (RJ-45)	100 meters

---

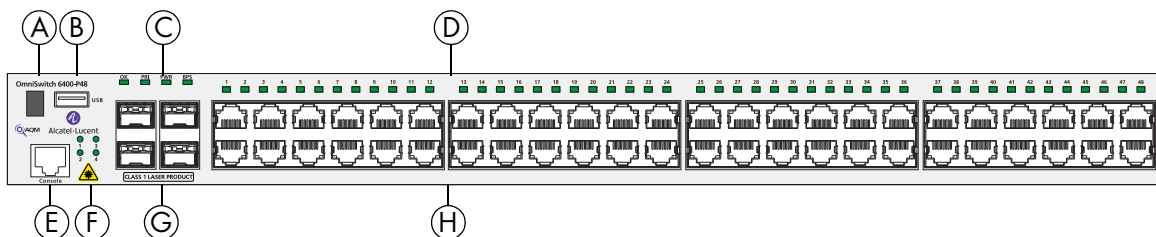
## OmniSwitch 6400-P48 Front Panel

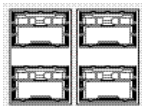

OS6400-P48 Front Panel

Item	Description	
A	<b>LED Indicator</b> Seven segment LED provides stack element ID.	
B	<b>USB Port</b> High speed USB 2.0 port.	
C	<b>System Status LEDs</b> Provides status on hardware, software, primary and redundant power. Refer to <a href="#">“LED Status Indicators” on page 2-20</a> for LED status information.	
D	<b>10/100/1000BaseT Ethernet LEDs</b> Provides link and traffic status. Refer to <a href="#">“LED Status Indicators” on page 2-20</a> for LED status information.	
E	<b>Console Port</b> RS-232 console port with an RJ-45 connector. Provides access to the CLI for configuration and management.	
F	<b>SFP Combo Port LEDs</b> Provides link and traffic status. Refer to <a href="#">“LED Status Indicators” on page 2-20</a> for LED status information.	
G	<b>SFP Combo Ports</b> Four combo (1-4) SFP connectors for various supported SFP transceivers. Odd-numbered ports are on top row, even-numbered ports are on bottom row.	
H	<b>10/100/1000BaseT RJ-45 PoE Ports</b> Forty-four 10/100/1000 BaseT non-combo (5–48) and four 10/100/1000 BaseT combo (1–4) PoE ports. Odd-numbered ports are on top row, even-numbered ports are on bottom row.	

## OmniSwitch 6400-P48 Rear Panel

**Note.** The figure shows a pre-production version of the chassis without product, safety, and compliance information labels. All production versions of the chassis have these labels.

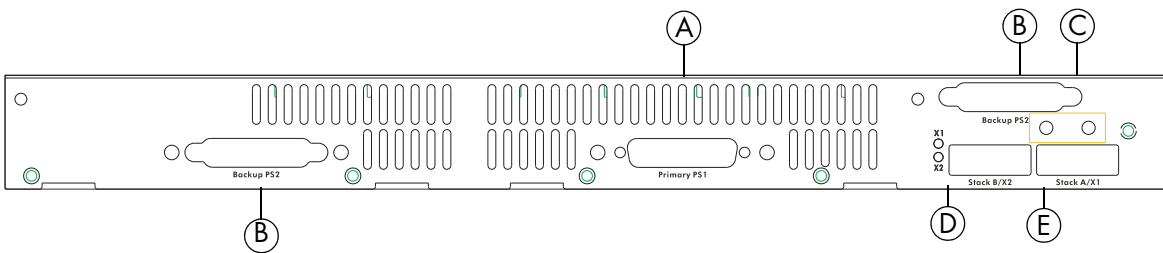

**OS6400-P48 Rear Panel**

Item	Description
A	<b>Primary PS1 Power Supply Connector</b> DB-25 connector for required external primary power supply.
B	<b>Redundant PS2 Power Supply Connector</b> DB-25 connector for optional external redundant power supply.
C	<b>Grounding Block</b> Type LCD8-10A-L grounding lug
D	<b>Stacking/Uplink LEDs</b> Provides link or traffic status for stacking/uplink connectors. Refer to <a href="#">“LED Status Indicators”</a> on page 2-20 for LED status information.
E	<b>Stacking/Uplink Connectors</b> Connectors for use in stacking switches into a virtual chassis or as an uplink port

**Note .** The rear panel of the OS6400-P48 contains three DB-25 power supply connectors for connecting external 360W and 510W power supplies. One of the connectors is labeled 'Primary PS1' and two of the connectors are labeled 'Backup PS2'. The primary power supply must be connected to the 'Primary PS1' connector. A redundant power supply can be connected to either of the 'Backup PS2' connectors.

---

## OS6400-P48 Specifications

---

Total non-combo 10/100/1000Base-T PoE ports per switch (5–48)	44
Total combo 10/100/1000 Base-T PoE combo ports per switch (1–4)	4
Total combo SFP connectors per switch (1–4)	4
Total 10/100/1000 Base-T PoE ports per stack	384 (stack of eight switches)
Total combo SFP connectors per stack	32 (stack of eight switches)
Power	Primary (External): 360W AC or 510W AC Redundant (External): 360W AC or 510W AC
Flash memory size	128 MB
RAM memory size	256 MB SDRAM
Width	17.32 in. (44.0 cm)
Height	1.73 in. (4.4 cm)
Height (rack units)	1 RU
Depth	17.75 in. (45.09 cm) (with external power supply) 10.75 in. (27.31 cm) (without external power supply)
Weight	9.92 lbs. (4.50 kg)
Relative Humidity	Operating: 5% to 95% (non-condensing) Storage: 5% to 95% (non-condensing)
Ambient Temperature	Operating: 32° F to 113° F (0 °C to 45 °C) Storage: 14° F to 158° F (-10 °C to 70 °C)
Altitude	Operating: Up to 10,000 ft. (3048 m) Storage: Up to 40,000 ft. (12192 m)
Maximum frame size	9216 bytes
Ethernet standards	802.3i (10BaseT), Cable: (Cat 5 UTP) 802.3u (100BaseTX), Cable: (Cat 5e/6 UTP, EIA/TIA 568) 802.3ab (1000Base-T), Cable: (Cat -5e/6, UTP, EIA/TIA 568) 802.3z (1000Base-X), Cable: (SMF, MMF) 802.3ah (EFM), Cable: (SMF, MMF)
Maximum cable distance (RJ-45)	100 meters

---

## LED Status Indicators

LED	State	Description
<b>OK</b>	Solid Green	System software is operational.
	Solid Amber	Hardware or System failure.
	Blinking Green	Normal Diagnostics.
	Blinking Amber	Switch operational but auto-configuration not successful.
<b>PRI</b>	Solid Green	Primary unit in a stack or standalone switch.
	Solid Amber	Secondary unit in a stack.
	Off	Switch is idle. (not primary or secondary)
<b>PWR</b>	Solid Green	Primary power supply operational.
	Solid Amber	Primary power supply failure.
	Off	Primary power supply not present.
<b>BPS</b>	Solid Green	Redundant power supply operational.
	Solid Amber	Redundant power supply failure.
	Off	Redundant power supply not present.
<b>10/100/1000</b>	Solid Green	Valid Link.
	Blinking Green	Transmitting or receiving packets in a link up state for non-PoE .
	Solid Amber	Valid PoE Link.
	Blinking Amber	Transmitting or receiving packets in a link up state for PoE .
	Off	No link.
<b>SFP</b>	Solid Green	Valid Link.
	Blinking Green	Transmitting or receiving packets .
	Off	No link.
<b>X1/X2</b>	Currently Not Supported.	N/A



# OmniSwitch 6400 Series Power Supplies

OmniSwitch 6400 Series switches support the following power supplies:

- PS-510W-AC Power Supply (see [“PS-510W-AC Power Supply” on page 2-22](#))
- PS-510W-AC-E Power Supply (see [“PS-510W-AC-E Power Supply” on page 2-23](#))
- PS-360W-AC Power Supply (see [“PS-360W-AC Power Supply” on page 2-24](#))
- PS-360W-AC-E Power Supply (see [“PS-360W-AC-E Power Supply” on page 2-25](#))
- PS-126W-AC Power Supply (see [“PS-126W-AC Power Supply” on page 2-26](#))
- PS-120W-DC Power Supply (see [“PS-120W-DC Power Supply” on page 2-27](#))
- 126W AC Internal Power Supply (see [“126W AC Internal Power Supply” on page 2-28](#))
- 120W DC Internal Power Supply (see [“120W DC Internal Power Supply” on page 2-28](#))

## PS-510W-AC Power Supply

The PS-510W-AC Power Supply provides system and PoE power and can be installed as either a primary or redundant power supply.



### 510W AC System/PoE Power Supply

P/S Component	Description
Model	PS-510W-AC
Provides Primary and Redundant System and PoE For	OS6400-P24 and OS6400-P48
Input Voltage Range	100 to 240 VAC
Rated Frequency	50 to 60 Hz
Maximum PoE Output Power	400 W
Maximum System Output Power	130 W
PoE Output Voltage	-50.0 VDC
PoE Output Current	8.2 A (maximum)
System Output Voltage	12.0 VDC (typical)
System Output Current	10.0 A (maximum)
Width	12.25 in. (31.12 cm)
Height	1.73 in. (4.4 cm) (1 RU)
Depth	6.25 in. (15.86 cm)
Weight	5.71 lbs. (2.59 kg)

## PS-510W-AC-E Power Supply

The PS-510W-AC-E Power Supply provides enhanced system and PoE power and can be installed as either a primary or redundant power supply.

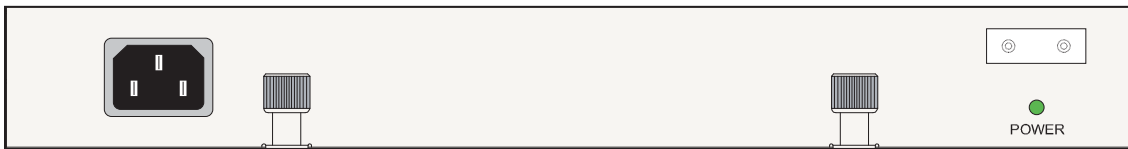

**510W AC Enhanced System/PoE Power Supply**

P/S Component	Description
Model	PS-510W-AC-E
Provides Primary and Redundant System and PoE For	OS6400-P24 and OS6400-P48
Input Voltage Range	90 to 264 VAC
Rated Frequency	47 to 63 Hz
Maximum PoE Output Power	410 W
Maximum System Output Power	120 W
PoE Output Voltage	-54.5 VDC
PoE Output Current	7.53 A (maximum)
System Output Voltage	12.2 VDC (typical)
System Output Current	10.0 A (maximum)
Width	12.25 in. (31.12 cm)
Height	1.73 in. (4.4 cm) (1 RU)
Depth	6.25 in. (15.86 cm)
Weight	5.71 lbs. (2.59 kg)

## PS-360W-AC Power Supply

The PS-360W-AC Power Supply provides system and PoE and can be installed as either a primary or redundant power supply.

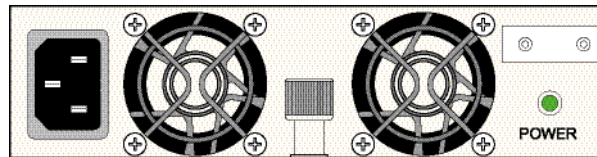
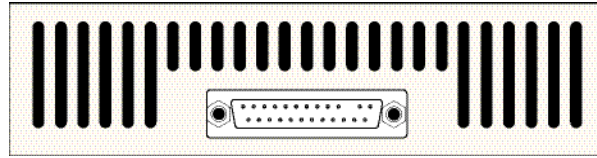

**360W AC System/PoE Power Supply**

P/S Component	Description
Model	PS-360W-AC
Provides Primary and Redundant System and PoE For	OS6400-P24 and OS6400-P48
Input Voltage Range	100 to 240 VAC
Rated Frequency	50 to 60 Hz
Maximum PoE Output Power	230 W
Maximum System Output Power	130 W
PoE Output Voltage	-50.0 VDC
PoE Output Current	4.6 A (maximum)
System Output Voltage	12.0 VDC (typical)
System Output Current	10.8 A (maximum)
Width	6.25 in. (15.86 cm)
Height	1.73 in. (4.4 cm) (1 RU)
Depth	6.25 in. (15.86 cm)
Weight	3.22 lbs. (1.46 kg)

## PS-360W-AC-E Power Supply

The PS-360W-AC-E Power Supply provides enhanced system and PoE and can be installed as either a primary or redundant power supply.

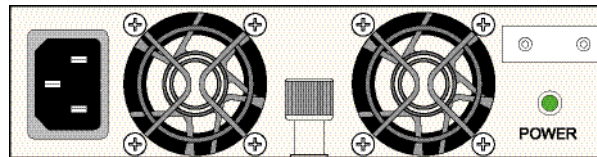
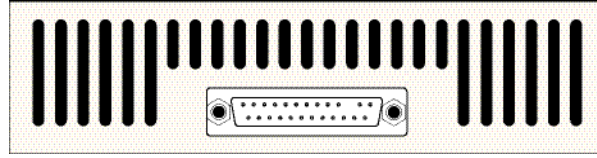

**360W Enhanced AC System/PoE Power Supply**

P/S Component	Description
Model	PS-360W-AC-E
Provides Primary and Redundant System and PoE For	OS6400-P24 and OS6400-P48
Input Voltage Range	90 to 264 VAC
Rated Frequency	47 to 63 Hz
Maximum PoE Output Power	230 W
Maximum System Output Power	130 W
PoE Output Voltage	-54.5 VDC
PoE Output Current	4.22 A (maximum)
Sytem Output Voltage	12.0 VDC (typical)
Sytem Output Current	10.8 A (maximum)
Width	6.25 in. (15.86 cm)
Height	1.73 in. (4.4 cm) (1 RU)
Depth	6.25 in. (15.86 cm)
Weight	3.22 lbs. (1.46 kg)

## PS-126W-AC Power Supply

The PS-126W-AC Power Supply provides system power and can be installed as a redundant system power supply.

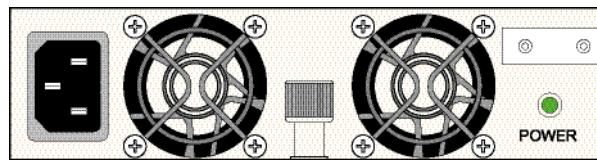
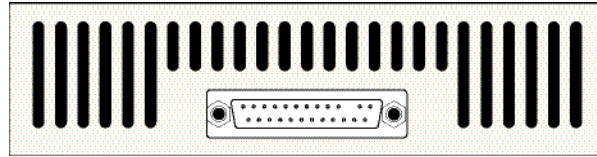

**126W AC System Power Supply**

P/S Component	Description
Model	PS-126W-AC
Provides Redundant System Power For	OS6400-24, OS6400-48, OS6400-U24, OS6400-U24D
Input Voltage Range	90 to 264 VAC
Rated Frequency	50 to 60 Hz
Maximum Output Power	126 W
Output Voltage	12.0 VDC (typical)
Output Current	10.5 A (maximum)
Width	6.25 in. (15.86 cm)
Height	1.73 in. (4.4 cm) (1 RU)
Depth	6.25 in. (15.86 cm)
Weight	2.45 lbs. (1.11 kg)

## PS-120W-DC Power Supply

The PS-120W-DC Power Supply provides full system power and can be installed as a redundant system power supply.

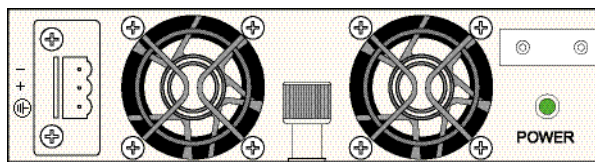
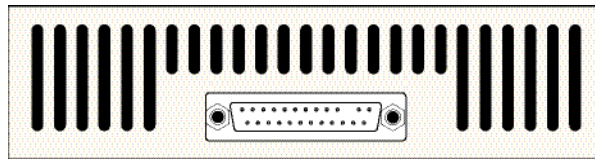

**120W -48VDC System Power Supply**

P/S Component	Description
Model	PS-120W-DC
Provides Redundant System Power For	OS6400-24, OS6400-48, OS6400-U24, OS6400-U24D
Input Voltage Range	36 to 72 VDC (24V Nominal Input)
Input Current	3.3A @ 48VDC
Maximum Output Power	120 W
Output Voltage	12.0 VDC (typical)
Output Current	10.0 A (maximum)
Width	6.25 in. (15.86 cm)
Height	1.73 in. (4.4 cm) (1 RU)
Depth	6.25 in. (15.86 cm)
Weight	2.09 lbs. (.95 kg)

## 126W AC Internal Power Supply

The 126W Internal Power Supply provides full system power.

P/S Component	Description
Model	126W AC Internal Power Supply
Provides Primary System Power For	OS6400-24, OS6400-48, OS6400-U24
Input Voltage Range	100 to 240 VAC
Rated Frequency	47 to 63 Hz
Maximum Output Power	126 W
Output Voltage	12.0 VDC (typical)
Output Current	10.8 A (maximum)

### 126W AC Internal System Power Supply

## 120W DC Internal Power Supply

The 120W DC Internal Power Supply provides full system power.

P/S Component	Description
Model	120W DC Internal Power Supply
Provides Primary System Power For	OS6400-U24D
Input Voltage Range	36 to 72 VDC (24V Nominal Input)
Input Current	3.3A @ 48VDC
Maximum Output Power	120 W
Output Voltage	12.0 VDC (typical)
Output Current	10.0 A (maximum)

### 120W -48VDC Internal System Power Supply



## Power Supply Shelf

Alcatel-Lucent requires the use of the power supply shelf when connecting power supplies. The shelf can be attached directly to the back of the chassis or rack mounted.

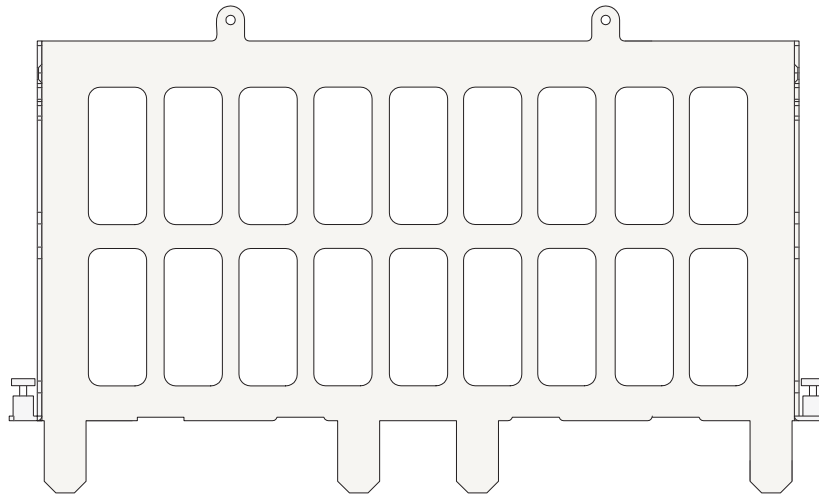

**OS6400 Power Supply Shelf**

## AC Power Cords

Since the power cord is the switch's only disconnect device, it should be plugged into an easily accessible outlet. In the event that your power cord is lost or damaged, refer to the specifications below.

### Specifications

The power cord included with this product contains three (3) insulated #18AWG stranded copper wires and is rated between 85-265 VAC (region dependent), 10 amps with a nominal length of 2 meters. The female end terminates in an IEC-60320-C15 attachment plug and the male end termination varies dependent upon region, as listed below.

European cords must be Harmonized (HAR) type. Refer to the information below for power plug types by region:

Power Cord Types	User Side Connectors
North America	NEMA 5-15-P
United Kingdom / Ireland	BS 1363 UK
Europe	CEE 7/7
Japan	JIS 8303
Australia	AS 3112
India	BS 546
Italy	CIE 23-16
Switzerland / Liechtenstein	SEV 1011
Denmark / Greenland	SRAF 1962 / DB 16/87
Argentina	A-10



**IEC-60320-C15**

#### Supplied OS6400 Power Cord Specifications

## DC Power Specifications

In addition to the installation steps described in [“Connecting a Power Supply to the Chassis” on page 3-13](#) and [“Rack Mounting Power Supplies” on page 3-15](#) DC power supplies have the following additional considerations:

- Connect to a -48V reliably grounded DC SELV source.
- Use common DC return connections for the DC power supplies. The DC return terminal conductor should be connected to the equipment frame.
- The Branch Circuit Overcurrent Protection must be rated a Maximum of 15A.
- Use 12AWG solid conductors only.
- A readily accessible disconnect device that is suitably approved and rated shall be incorporated in the field wiring.

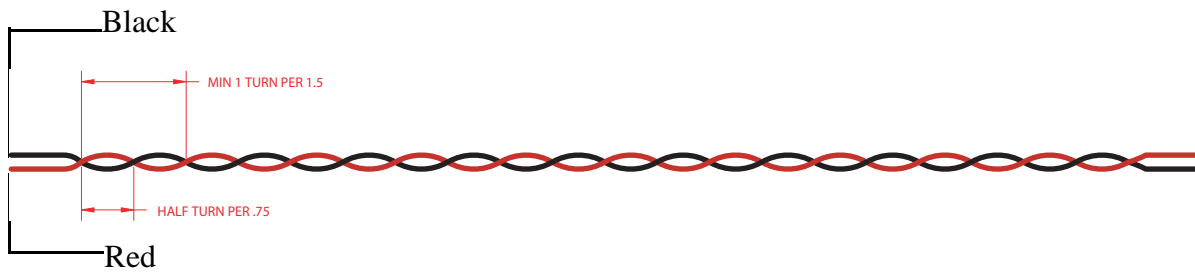

**Twisted pair wire (red and black) for a DC power supply**

# Console Port

The console port, located on the chassis front panel, provides a console connection to the switch and is required when logging into the switch for the first time. By default, this RJ-45 connector provides an RS-232 DTE console connection.

## Serial Connection Default Settings

The factory default settings for the serial connection are as follows:

<b>baud rate</b>	9600
<b>parity</b>	none
<b>data bits (word size)</b>	8
<b>stop bits</b>	1
<b>flow control</b>	none

## Modifying the Serial Connection Settings

The switch's serial connection defaults are listed above. If you wish to modify the default serial connection settings (i.e., baud rate, parity, data bits, and stop bits), refer to the following steps:

---

**Note.** You must be connected to the switch via the console port before attempting to change serial connection settings. Otherwise, an error message will display.

For switches in a stacked configuration, all changes must be configured before the switches are cabled together. In other words, you must configure these settings when each switch is operating as a stand-alone unit.

---

- 1 Enter the **modify boot parameters** command at the CLI prompt. The boot prompt displays:

```
Boot >
```

- 2 To change the baud rate, enter **boot serialbaudrate**, followed by the desired baud rate value. Options include 1200, 2400, 4800, 9600 (default), 19200, 38400, 57600, 76800, and 115200. For example:

```
Boot > boot serialbaudrate 19200
```

---

**Note.** Setting the console port to speeds above 9600 baud can cause problems with Zmodem uploads.

---

- 3 To change the parity value, enter **boot serialparity**, followed by the desired parity value. Options include none (default), even, and odd. For example:

```
Boot > boot serialparity even
```

- 4 To change the data bits (i.e., word size) value, enter **boot serialwordsize**, followed by the number of data bits. Options include 7 and 8 (default). For example:

```
Boot > boot serialwordsize 7
```

- 5** To change the stop bits value, enter **boot serialstopbits**, followed by the number of stop bits. Options include 1 (default) and 2. For example:

```
Boot > boot serialstopbits 2
```

- 6** Verify your current changes by entering **show** at the boot prompt:

```
Boot > show
Edit buffer contents:
Serial (console) baud      : 19200
Serial (console) parity   : even
Serial (console) stopbits : 2
Serial (console) wordsize : 7
```

*(additional table output not shown)*

- 7** You can save your changes to the **boot.params** file by entering **commit file** at the boot prompt:

```
Boot > commit file
```

When the **commit file** command is used, changes will not be enabled until after the next switch reboot.

- 8** You can also save your changes in real time to the switch's running memory by entering **commit system** at the boot prompt:

```
Boot > commit system
```

---

**Note.** There are two important things to consider when using the **commit system** command to save serial connection changes:

- Output to the terminal may become illegible due to incompatible serial connection settings between the switch and the terminal emulation software.
- If you use the **commit system** command only, changes will *not* be saved to the switch's **boot.params** file and will be lost if the switch is rebooted. To save changes to the **boot.params** file, refer to step 7.

- 
- 9** Return to the CLI prompt by entering **exit** at the boot prompt.

## Port Pinouts

### 10/100 Ethernet Port – RJ-45 Pinout (non-PoE)

Pin Number	Description
1	RX+
2	RX-
3	TX+
4	not used
5	not used
6	TX-
7	not used
8	not used

### Gigabit Ethernet Port – RJ-45 Pinout

Pin Number	Description
1	BI_DB+
2	BI_DB-
3	BI_DA+
4	BI_DD+
5	BI_DD-
6	BI_DA-
7	BI_DC+
8	BI_DC-

### 10/100/1000 Mbps Power over Ethernet Port – RJ-45 Pinout

Pin Number	Description
1	RX+ (-VDC)
2	RX- (-VDC)
3	TX+ (+VDC)
4	not used
5	not used
6	TX- (+VDC)
7	not used
8	not used

**RJ-45 Console Port – Connector Pinout**

<b>Pin Number</b>	<b>Signals as DTE Console Port</b>
1	NC
2	NC
3	RXD
4	Ground
5	Ground
6	TXD
7	NC
8	NC





# 3 Mounting OS6400 Switches

---

**Note.** Never obstruct the air intake or exhaust vents located on the chassis. Obstructing these vents can cause switch failure. Always follow the recommended clearance values.

---

## General Mounting Recommendations

Be sure that your switch is placed in a well-ventilated, static-free environment. Always allow adequate clearance at the front, rear, top, and sides of the switch. Refer the table below for detailed information on recommended chassis clearances.

## Recommended Clearances

The following table shows the recommended minimum clearances for adequate chassis airflow and access to cabling and components at the front and rear of the chassis.

---

<b>Location</b>	
Top	No minimum clearance required. However, be sure that the top of the chassis is not in direct contact with any equipment above.
Bottom	No minimum clearance required. However, be sure that the bottom of the chassis is not in direct contact with any equipment below.
Sides	2 inches
Rear	6 inches (see note below)
Front	6 inches (see note below)

---

**Note.** Clearance recommendations at the front and rear of chassis are for access to cabling and components only and are not intended as a specific airflow requirement. If a redundant power supply is to be attached directly to the rear of the switch chassis (see [page 3-13](#)), additional clearance will be required to accommodate the power supply tray.

---

## Elevated Operating Ambient Temperatures

If installed in a closed or multi-unit rack assembly, the operating ambient temperature of the rack environment may be greater than room ambient. Therefore, consideration should be given to installing the equipment in an environment compatible with the maximum ambient temperature ( $T_{ma}$ ) specified by the manufacturer.

## Reduced Air Flow

Installation of the equipment in a rack should be such that the amount of air flow required for safe operation of the equipment is not compromised.

## Mechanical Loading

Mounting of the equipment in the rack should be such that a hazardous condition is not achieved due to uneven mechanical loading.

## Circuit Overloading

Consideration should be given to the connection of the equipment to the supply circuit and the effect that overloading of the circuit might have on overcurrent protection and supply wiring. Appropriate consideration of equipment nameplate ratings should be used when addressing this concern.

## Reliable Earthing

---

**Note.** Reliable earthing of rack-mount equipment should be maintained. Particular attention should be given to supply connections other than direct connections to the branch circuit (e.g. use of power strips). If you are relocating the switch, be sure to power it down and remove all network, stacking, and power cables before moving.

---

# Airflow Recommendations

The OmniSwitch 6400 draws air from intake vents located in the left chassis panel and exhausts air via fan vents located in the right chassis panel.

For each switch, air is directed horizontally through the chassis, where it passes over the circuit board and provides necessary cooling for internal components. Refer to the diagram below for more information.

**1. Air Intake.** The chassis fans pull air from the main air intake vents located in the left-hand panel of the chassis.

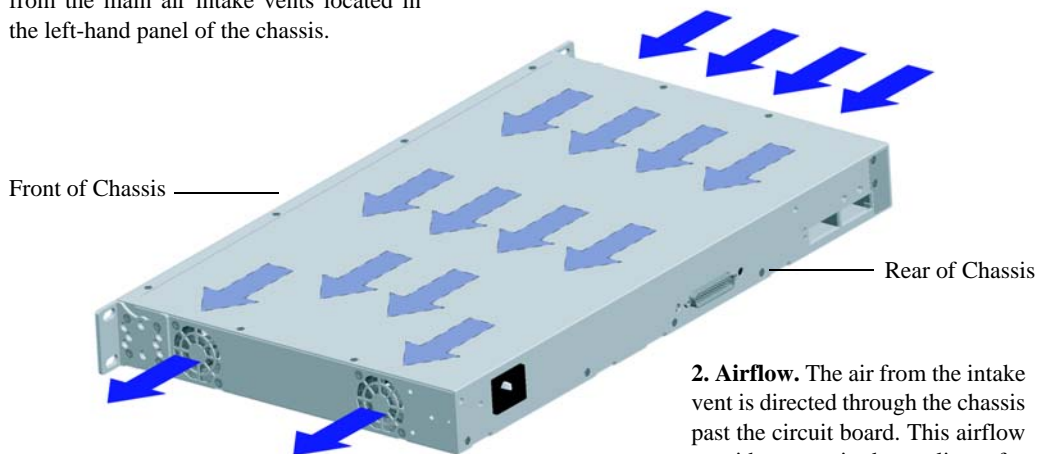

**3. Air Exhaust.** The airflow is exhausted through the fan exhaust vents at the right-hand side of the chassis.

**2. Airflow.** The air from the intake vent is directed through the chassis past the circuit board. This airflow provides required cooling for chassis components.

## Fan Speed Control

Depending on the temperature of the chassis the fans speed will vary according to the table below.

---

<b>Current Fan Speed:</b>	<b>Temperature (Celsius)</b>	<b>Fan Speed Set To:</b>	<b>Fan Rate</b>
Very Low	>= 30	Low	25%
Low	<= 27	Very Low	15%
	>= 33	Medium	50%
Medium	<= 30	Low	25%
	>= 36	High	90%
High	<= 33	Medium	50%
	>= 39	Full	100%
Full	<= 36	High	90%

---

**Note:** The fan will never be turned off completely. At it's lowest setting it will always be running at the the Very Low speed setting (15%).

---

# Installation Overview

OmniSwitch 6400 Series switches can be installed in various configurations. Refer to the guidelines below before mounting the chassis and power supplies.

---

**Note.** OmniSwitch 6400 Series switches must be placed “right side up.” Never attempt to operate a switch positioned on its side.

---

## Mounting Guidelines

- Installation of a power supply shelf and external power supply is required for PoE-ready OmniSwitch 6400 Series models (OS6400-P24 and OS6400-P48). All other models have an internal power supply and external power supplies are only needed if power redundancy is required.
- Be sure that adequate clearance has been provided for chassis airflow and access to the front, back, and sides of the switch. For recommended clearances, refer to [page 3-1](#).
- Be sure that you have placed the chassis within reach of all the required AC or DC power sources.
- If you are placing multiple switches in a stacked configuration Be sure to maintain adequate clearance at the front, rear, left, and right side of all switches (see [page 3-1](#)). Up to eight switches may be stacked to form a single virtual chassis. Also, be sure that you have placed all switches in the stack within reach of required power sources and necessary cables once the switches are stacked together. See “[Cabling Stacked Configurations](#)” on [page 3-10](#).

## Mounting Options

The OmniSwitch 6400 Series switches can be installed in the following ways:

- Tabletop installation with no external power supply (for OS6400-24 and OS6400-48 switches with no power redundancy requirements)
- Tabletop installation with power supply directly attached to chassis (for OS6400-P24 and OS6400-P48 models or any OS6400 chassis with power redundancy)
- Rack-mount installation with no external power supply (for OS6400-24 and OS6400-48 switches with no power redundancy requirements)
- Rack-mount installation with power supply directly attached to rear of the chassis (for OS6400-P24 and OS6400-P48 models or any OS6400 chassis with power redundancy)
- Rack-mount installation with power supply rack-mounted and connected with cable (for OS6400-P24 and OS6400-P48 models or any OS6400 chassis with power redundancy)

---

**Important Note.** If an external power supply is to be used (PoE or redundant power configurations), be sure to install the power supply shelf and all external power supplies before table or rack-mounting the chassis. Instructions for installing the power supply shelf and external power supplies are provided on [page 3-13](#).

---

# Tabletop Installation

OmniSwitch 6400 Series switches can be installed as a tabletop unit.

---

**Note.** Be sure that adequate clearance has been provided for chassis airflow and access to the front, back, and sides of the switch. For recommended clearances, refer to “[Recommended Clearances](#)” on [page 3-1](#). Also, be sure that you have placed the chassis within the reach of all the required AC power sources.

---

To install the switch as a tabletop unit, follow the steps below:

**1** If no external power supply is required for this installation, skip to step 2.

If a PoE-ready switch (OS6400-P24 and OS6400-P48) or non-PoE switch *with redundant system power* is being installed, begin this installation by securing an external power supply shelf and power supply to the back of the chassis as described on [page 3-13](#). After completing the power supply shelf and external power supply installation, return to this section to complete the steps below.

**2** Remove the factory installed attachment screws and mounting brackets from the left and right sides of the switch chassis and set them aside.

**3** Table mounted switches can be screwed directly to the table using a table mount flange kit (available from Alcatel-Lucent). (The table mount flanges also provide rubber feet to protect the table surface.) If this kit is to be used, orient the table mounting brackets so that the rubber bumper faces down and attach the brackets to both the left and right side of the switch using the attachment screws removed at step (refer to illustration below).

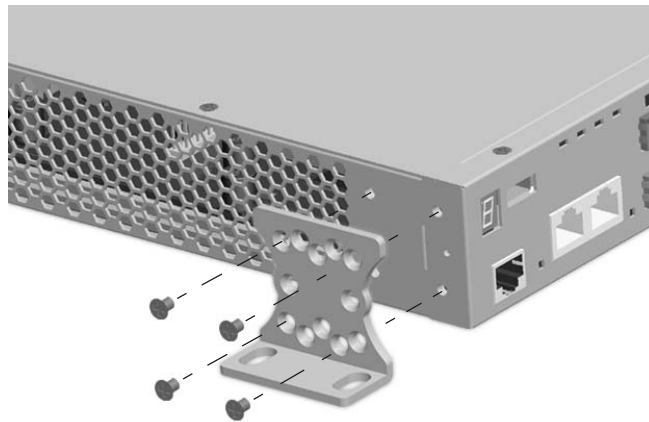

---

**Note.** The optional table mount flange kit is not mandatory. If the switch does not need to be firmly secured to the table surface, simply place the switch on the table surface.

---

- 4** If the table mount flange kit is being used, install the table mount brackets to the rear portion of the chassis.

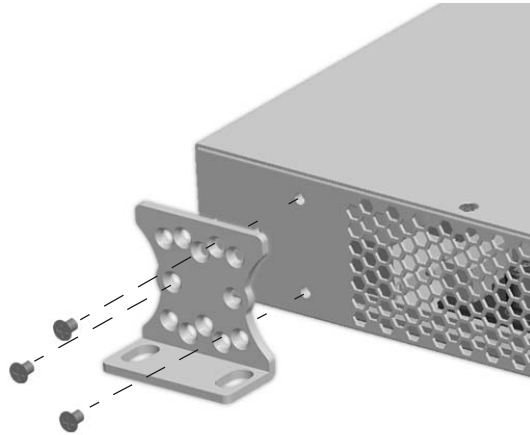

- 5** Mount the switch assembly on the table by inserting attachment screws through the flat portion of the mounting brackets and into the mounting surface.

## Next Steps

### Powering On the Switch

To power on the chassis refer to [“Connecting Chassis to Power Source”](#) on page 3-19.

### Stacking Multiple Switches Into a Virtual Chassis

To stack multiple switches into a virtual chassis, refer to [“Setting Up a Stacked Configuration”](#) on page 3-10.

# Rack-Mount Installation

## Rack Mount Guidelines

Refer to the important guidelines below before installing the OmniSwitch 6400 Series chassis on a rack.

- It is recommended that two people install the switch on the rack—one person to hold the chassis and position it on the rack, and a second person to secure the chassis to the rack using attachment screws (not supplied).
- Alcatel-Lucent provides two rack-mount flanges with each OmniSwitch 6400 Series switch. These flanges support standard 19-inch rack-mount installations. These flanges must be attached to the chassis before the switch can be rack mounted.

---

**Note.** If you are installing the switch in a 23-inch-wide rack, Alcatel-Lucent offers optional 23-inch rack-mounting hardware. For more information, contact your Alcatel-Lucent representative.

---

- Alcatel-Lucent does not provide rack-mount screws. Use the screws supplied by the rack vendor.
- To prevent a rack from becoming top heavy, it is recommended that you install heavier equipment at the bottom of the rack, whenever possible.
- If you are installing the switch on a relay rack, be sure to install and secure the rack per the rack manufacturer's specifications.
- Review [page 3-1](#) for important chassis airflow and access recommendations before installing.

## Rack Mounting Steps

- 1 If no external power supply is required for this installation, skip to step 2.

External power supplies can be installed directly to the rear of the chassis or in the rack directly above or below the switch. If an external power supply is being mounted to the rear of the chassis, begin this installation by following the steps beginning on [page 3-13](#). After completing the power supply shelf and external power supply installation, return to this section and complete the steps below.

---

**Rack Mounting Power Supplies.** Detailed information on rack mounting power supplies is provided on [page 3-8](#).

---

- 2 Mark the holes on the rack where the switch is to be installed.
- 3 Lift and position the switch until the factory installed rack mount flanges are flush with the rack post.
- 4 Align the holes in the flanges with the rack holes that were marked in step 2.



**5** Once the holes are aligned, insert a rack mount screw (not provided) through the *bottom hole of each flange*. Tighten both screws until they are secure.

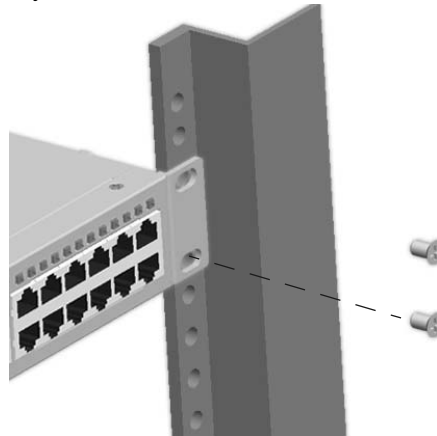

**Attaching the Switch to the Rack**

---

**Note.** Be sure to install the screws in the *bottom hole* of each flange, as shown, before proceeding.

---

**6** Once the screws at the bottom of each flange are secure, install the remaining rack mount screw. Be sure that all screws are securely tightened.

## Next Steps

### Rack Mounting Power Supplies

Detailed information on rack mounting power supplies is provided on [page 3-8](#).

### Powering On the Switch

To power on the chassis refer to “[Connecting Chassis to Power Source](#)” on [page 3-19](#).

### Stacking Multiple Switches Into a Virtual On the Switch

To stack multiple switches into a virtual chassis, refer to “[Setting Up a Stacked Configuration](#)” on [page 3-10](#).

# Setting Up a Stacked Configuration

## Rack Mounting Stacked Configurations

Prior to setting up and cabling the stacked configuration, be sure that all switches are in place and installed according to the instructions beginning on page 3-6 (table mount configuration) or 3-8 (rack mount configuration). Up to eight switches may be stacked to form a single virtual chassis.

---

**Note.** When rack mounting multiple switches in a stacked configuration, be sure to position all switches in the rack so that all required stacking cables will have adequate length for the installation.

---

## Cabling Stacked Configurations

In order to connect stacked switches into a virtual chassis, all modules in the stack must be connected via stacking cables.

### Redundant Stacking Cable Connections

In addition to the stacking cables installed between adjacent switch, the top-most switch and bottom-most switch in the stack must be connected using a redundant stacking cable.

### Recommended Cabling Patterns

Switches in a stack are connected to each other by stacking cables. The valid cable lengths are 1.5m (4.9 feet), 60cm (23.6 inches), and 30cm (11.8 inches). These stacking cables provide high-speed, dual-redundant links between switches in a stack.

For a stack to have effective redundancy, *a redundant stacking cable must be installed between the upper-most and bottom-most switch at all times.* This provides effective failover in the event of a stacking link or module failure within the stack.

The diagram below shows the recommended stacking cable pattern.

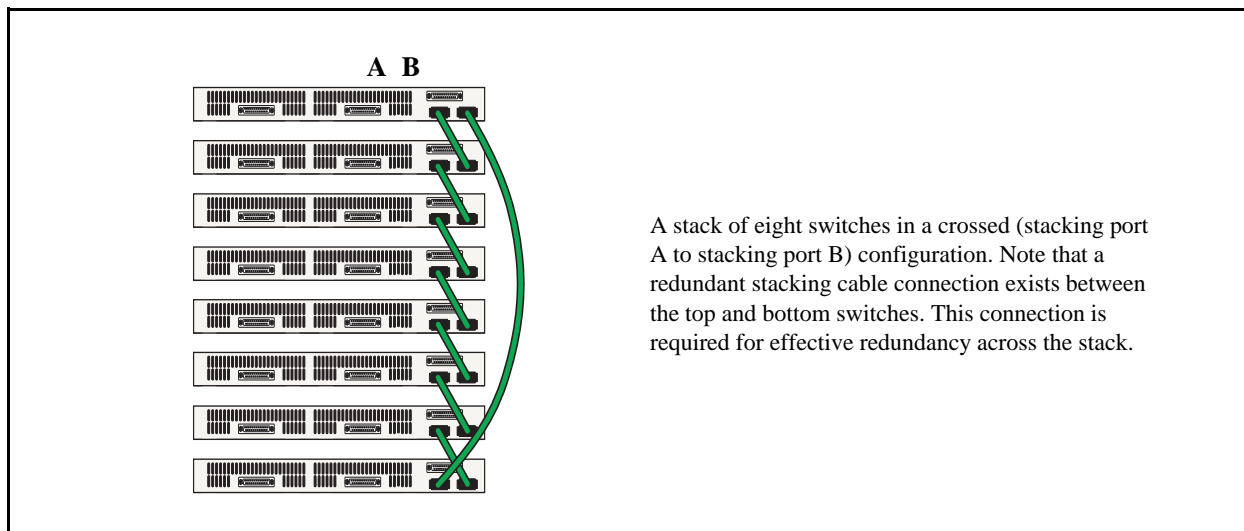

**Recommended Stacking Cable Patterns (Chassis Rear Panels Shown)**

## Cabling Steps

**1** Before inserting a stacking cable into one of the stacking, be sure to orient the stacking cable connector properly. The wide portion of the connector must be facing up. Refer to the diagram below for more information.

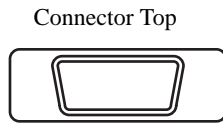

When orienting the stacking cable connector, be sure that the wider portion of the connector is facing up as shown. Otherwise, the stacking cable will not fit properly in the chassis' stacking port.

### End View of Stacking Cable Connector

**2** Starting from the top of the stack, insert one end of the stacking cable into either stacking port A or stacking port B. The stacking port (A or B) depends on your preferred cabling pattern. Be sure that cable connector is completely inserted and fully seated in the chassis.

**3** Insert the other end of the stacking cable into the stacking port of the switch immediately below. Once again, the stacking port (A or B) depends on the preferred cabling pattern.

**4** Repeat this procedure until all switches in the stack are connected (see illustrations a, b, and c below).

---

**Reminder.** The diagram below shows one supported stacking cable pattern. For additional supported cabling patterns, refer to [Chapter 5, "Managing OmniSwitch 6400 Series Stacks."](#)

---

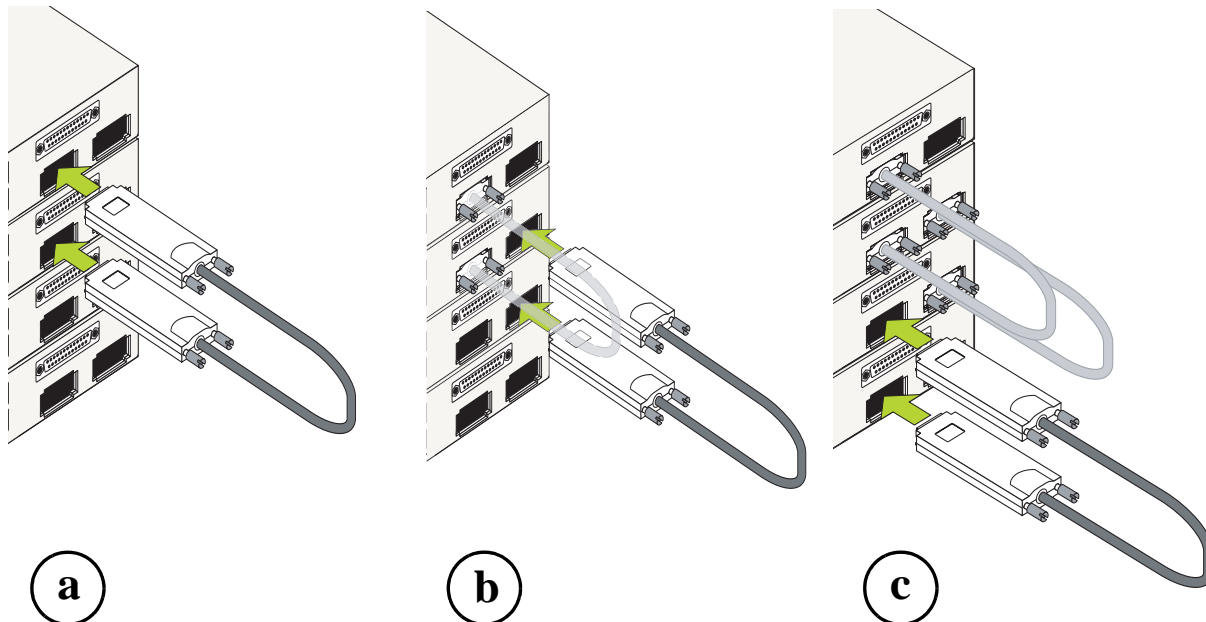

Connecting the Switches in the Stack

**5** To provide added resiliency and redundancy, *you must install the redundant stacking cable* to connect the top switch in the stack to the bottom switch. Connect the redundant cable now. Refer to the diagram below for more information:

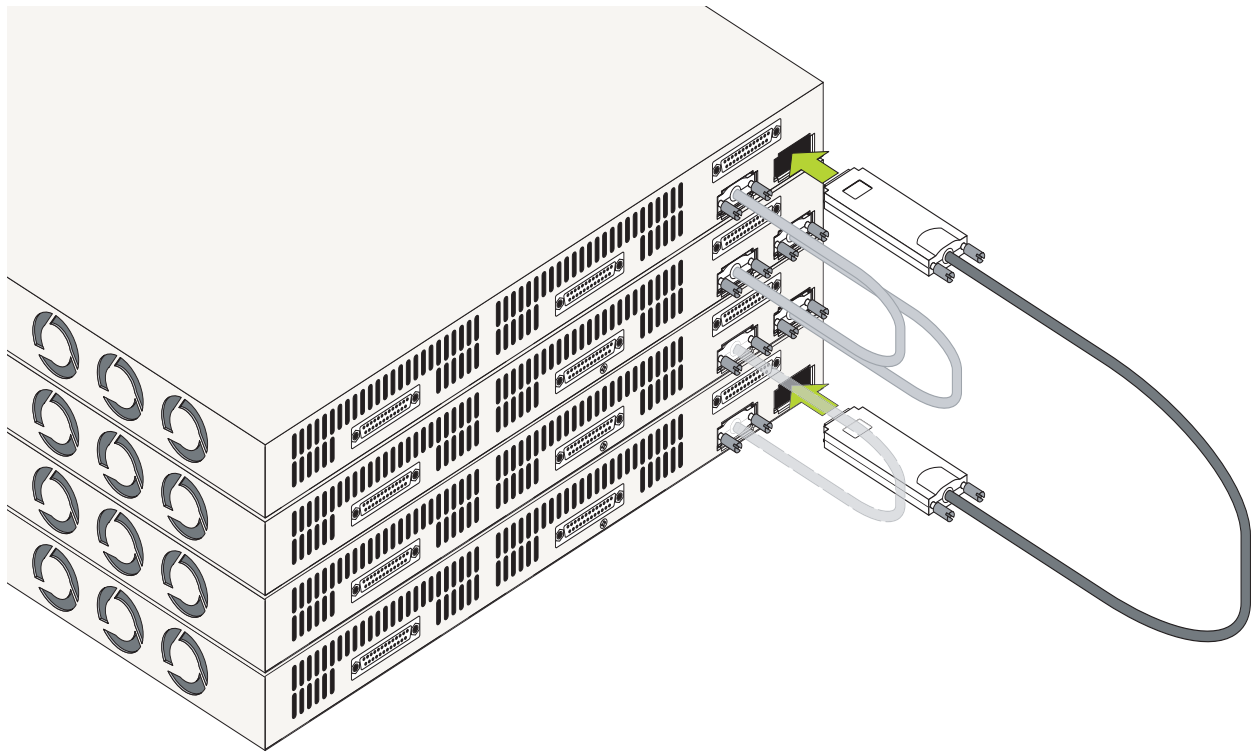

**Redundant Connection Between Top and Bottom Switches**

**6** Once all stacking cable connectors are inserted, tighten the captive screws at the left- and right-hand sides of each connector as shown. *Be sure not to overtighten the screws.*

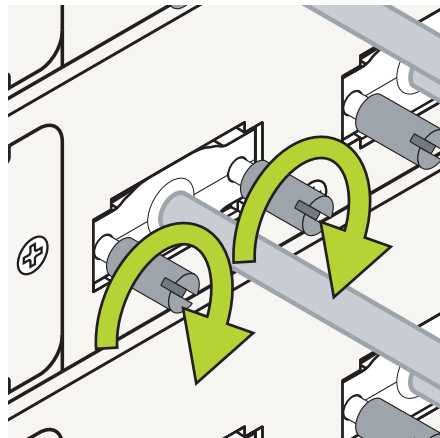

**Tightening Stacking Connector Captive Screws**

**7** Now that all switches in the stack are connected, continue to [“Connecting Chassis to Power Source” on page 3-19.](#)

# Installing Power Supplies

OmniSwitch 6400 Series power supply can be installed in the following ways:

- As a primary or backup supply directly connected to the back of an OmniSwitch 6400 Series chassis. See [“Connecting a Power Supply to the Chassis”](#) below for more information.
- As a primary or backup supply rack mounted directly above or below the switch and connected with a cable. See [“Connecting Chassis to Power Source”](#) on page 3-19 for more information.

DC power supplies require additional installation steps. See [“DC Power Specifications”](#) on page 2-31 for more information.

---

**Anti-Static Warning.** Before handling any components, free yourself of static by wearing a grounding strap, or by grounding yourself properly. Static discharge can damage the switch and the backup power supply.

---

## Connecting a Power Supply to the Chassis

Follow the steps below to connect a power supply directly (i.e., without a cable) to the rear of an OmniSwitch 6400 Series chassis.

---

**Note.** For information on rack mounting power supplies and connecting the power supply via a connector cable, refer to [“Rack Mounting Power Supplies”](#) on page 3-15.

---

- 1 Place the chassis, power supply, and shelf on a smooth, clean, and dry surface.
- 2 Carefully slide the power shelf so that it is flush against the back of the chassis.

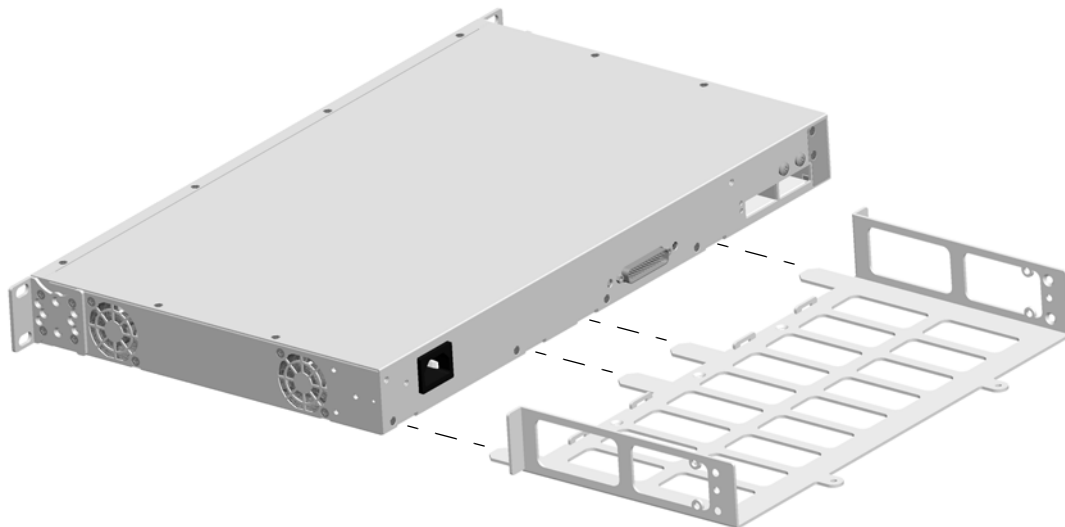

- 3 Tighten the two captive screws located on the left and right sides of the power shelf.

- 4 Carefully slide the power supply against the back of the chassis until the power connectors securely connect.

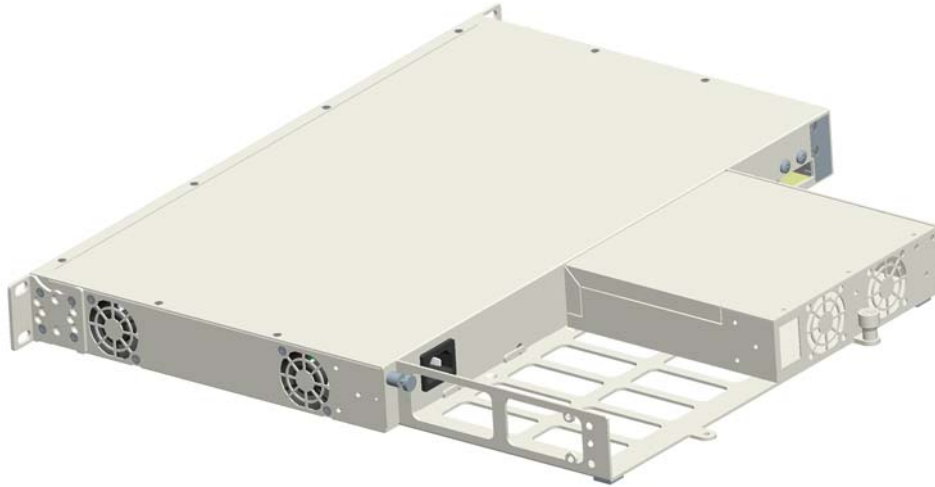

- 5 Verify that the captive screw for the power supply is aligned with the threaded hole in the power supply shelf. Secure the power supply to the power supply shelf by tightening the captive screw.
- 6 Repeat the steps above for any additional required power supplies.

## Next Steps

### Mounting the Switch

For information on table mounting the switch and power supply tray, refer to [“Tabletop Installation” on page 3-6](#). For information on rack mounting the switch and power supply tray, refer to [“Rack-Mount Installation” on page 3-8](#).

### Powering On the Switch

To power on the chassis refer to [“Connecting Chassis to Power Source” on page 3-19](#).

### Stacking Multiple Switches Into a Virtual On the Switch

To stack multiple switches into a virtual chassis, refer to [“Setting Up a Stacked Configuration” on page 3-10](#).

# Rack Mounting Power Supplies

The following sections describe how to rack-mount a power supply shelf and connect the power supply with a cable.

---

**Note.** For information on connecting a power supply directly to the rear of the chassis (without a connector cable), refer to [“Connecting a Power Supply to the Chassis”](#) on page 3-13.

---

## Power Supply Shelf Rack Mounting Steps

Follow the steps below to rack-mount the power supply shelf:

- 1** Align the threaded holes in the provided rack-mount flanges with the two holes in the power supply shelf. These holes are located on the left and right sides of the shelf.
- 2** Attach the flanges to the chassis using the provided Phillips-head screws. The screws slide through the non-threaded holes from the inside of the power supply shelf and are then attached to the mounting brackets using the threaded holes. Be sure to tighten each of the screws firmly using a Phillips screwdriver.

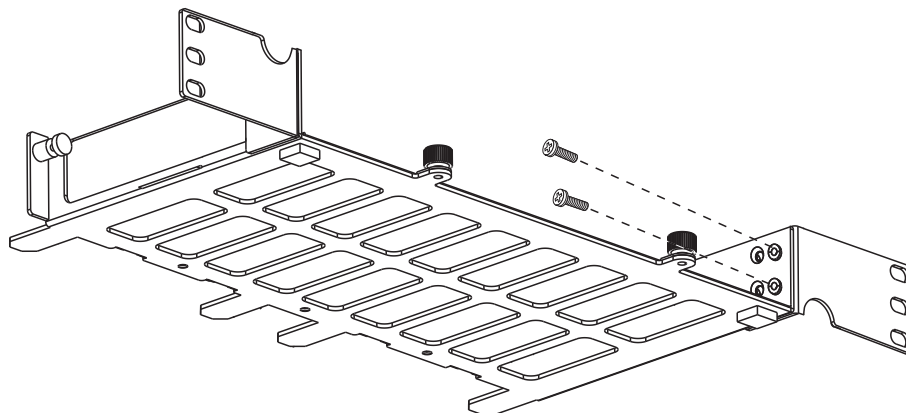

### Attaching a Rack-Mount Flange

- 3** Carefully slide the power supply on to the power shelf and secure the power supply to the shelf using the captive screws.

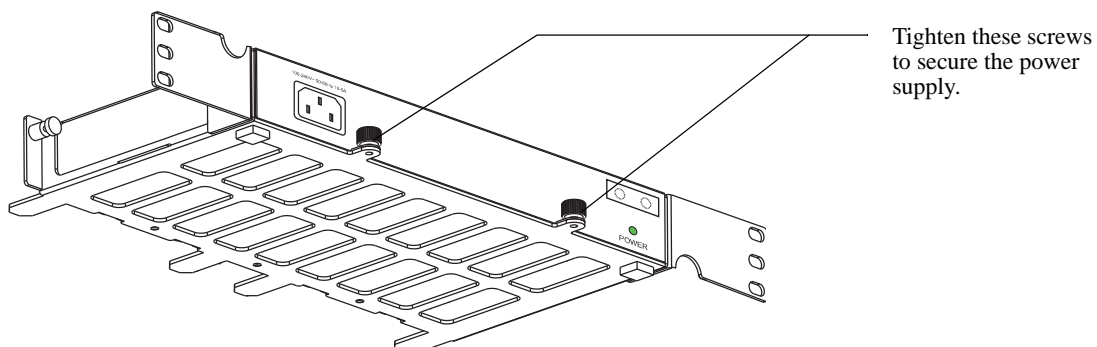

### Attaching a Power Supply to the Power Shelf

---

**Note.** A single 510W power supply or up to two of any other power supply types can be attached to a power supply shelf.

---

- 4** After the rack-mount flanges and the power supply are secured to the shelf, mark the holes on the rack where the shelf is to be installed.
- 5** Lift and position the shelf until the rack-mount flanges are flush with the rack post.
- 6** Align the holes in the flanges with the rack holes that were marked earlier.
- 7** Once the holes are aligned, insert a rack mount screw (not provided) through the *bottom hole of each flange*. Tighten both screws until they are secure.

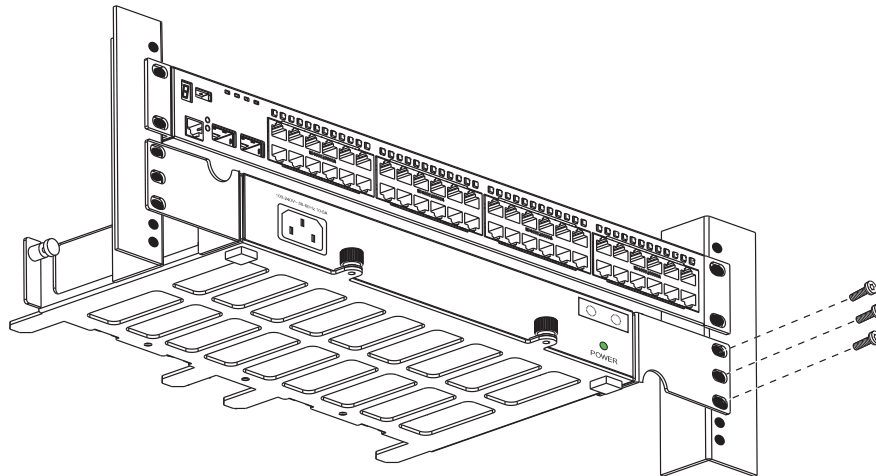

**Attaching the Power Shelf to the Rack**

---

**Note.** Be sure to install the screws in the *bottom hole* of each flange, as shown, before proceeding.

---

- 8** Once the screws at the bottom of each flange are secure, install the remaining two rack mount screws. Be sure that all screws are securely tightened.

### **Connecting the Power Supply Cable to the Chassis**

Follow the steps below to connect a power supply with a cable:

- 1** Be sure the switch and power shelf are securely fastened to the rack.
- 2** Connect the proper end of the supplied power supply cable to the appropriately labeled primary or backup connector on the switch and tighten securely.
- 3** Connect the other end of the power supply cable to the power supply and securely tighten.
- 4** Connect the power cord to the power supply.



**Note.** The diagrams below show examples of mounting the switch and power supplies in both a 2U and 3U scenario. Depending on the switch model, power supplies, and rack mounting options the actual mounting options will vary.

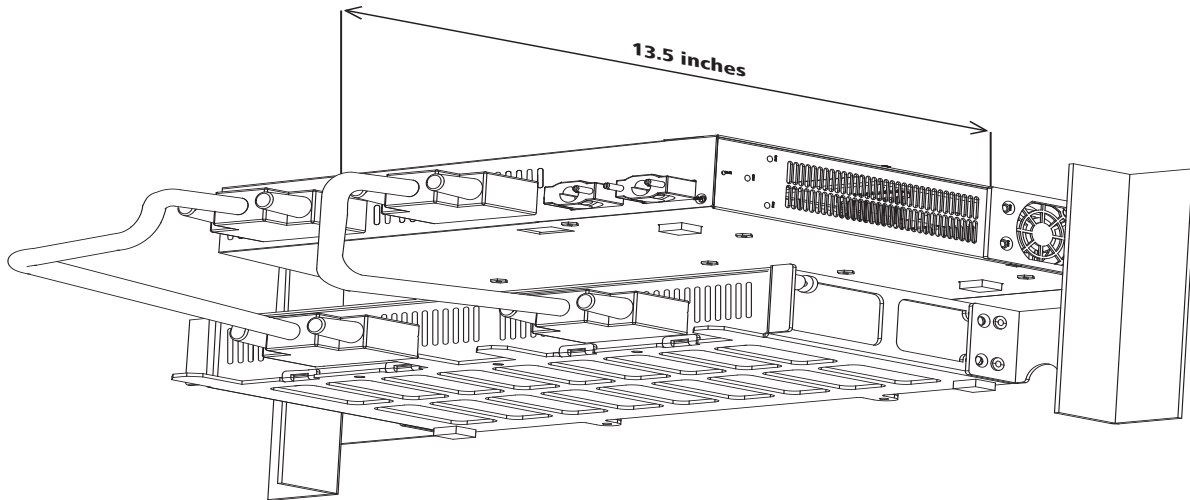

**Redundant 120W-DC, 126W-AC, 360W-PoE**

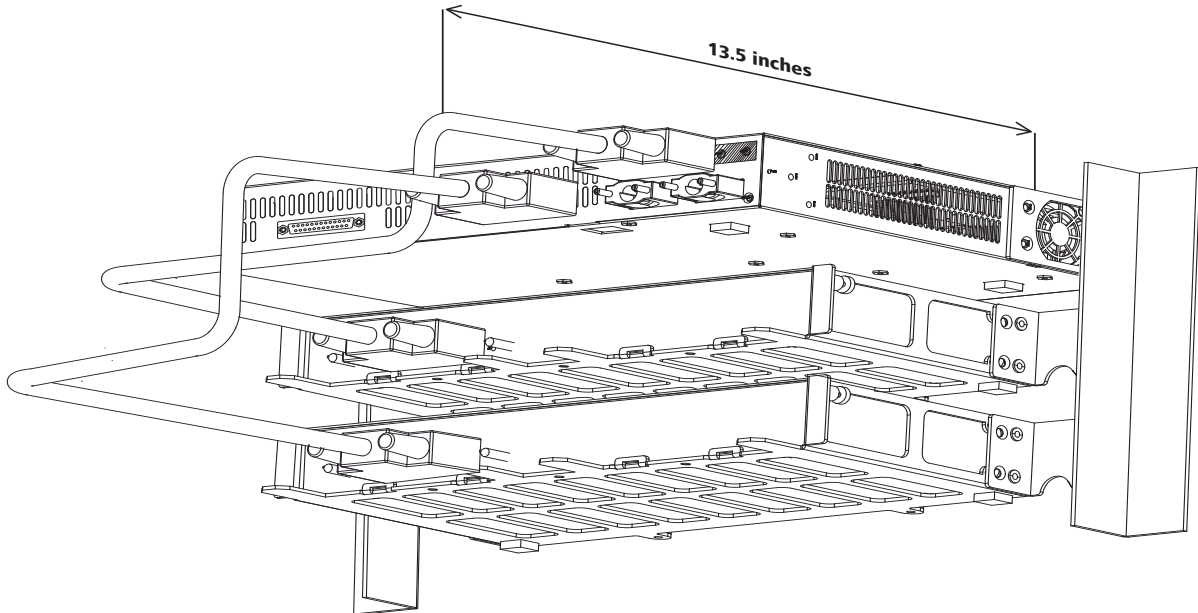

**Redundant 510W-PoE**

You can also attach the power supplies to the back of an OmniSwitch 6400 Series chassis directly as well as using cables at the same time, as shown in the diagram below.

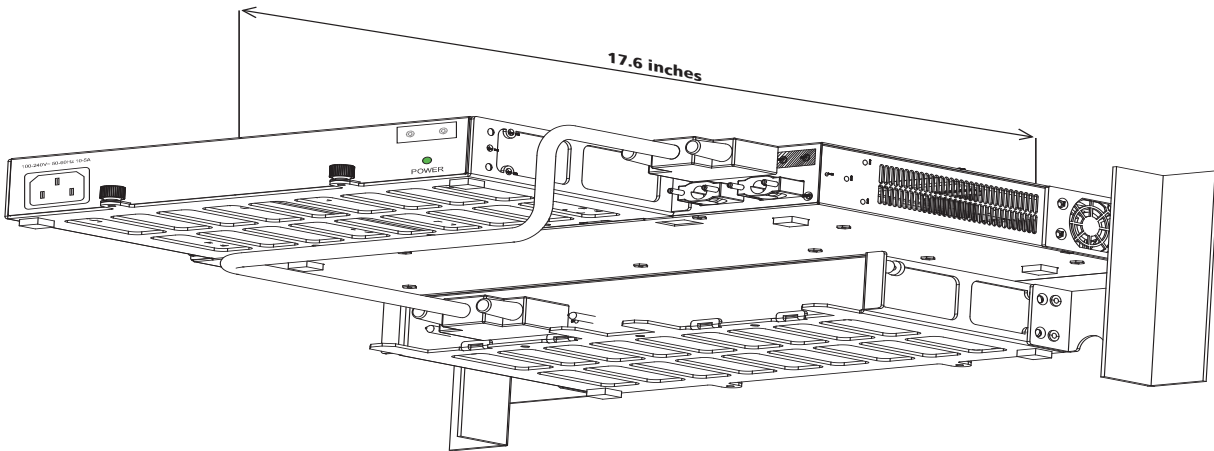

**Redundant 510W-PoE**

## Next Steps

### Powering On the Switch

To power on the chassis refer to [“Connecting Chassis to Power Source”](#) on page 3-19.

### Stacking Multiple Switches Into a Virtual On the Switch

To stack multiple switches into a virtual chassis, refer to [“Setting Up a Stacked Configuration”](#) on page 3-10.

# Connecting Chassis to Power Source

## AC Power Supply Connections

Since the power cord is the switch's only disconnect device, it should be plugged into an easily accessible outlet. In the event that your power cord is lost or damaged, refer to the specifications below.

### Powering On a Chassis

Follow the steps below to power on the chassis using an AC power source:

- 1** Connect the IEC-60320-C15 end of the supplied power cord to the primary and optional redundant power supply.
- 2** Connect the country specific ends of the supplied power cord to the AC power source.
- 3** Monitor the chassis as it boots.

## DC Power Supply Connections

In addition to the installation steps described in “Connecting a Power Supply to the Chassis” on page 3-13 and “Rack Mounting Power Supplies” on page 3-15 DC power supplies have the following additional considerations:

- Connect to a -48V reliably grounded DC SELV source.
- Use common DC return connections for the DC power supplies. The DC return terminal conductor should be connected to the equipment frame.
- The Branch Circuit Overcurrent Protection must be rated a Maximum of 15A.
- Use 12AWG solid conductors only.
- A readily accessible disconnect device that is suitably approved and rated shall be incorporated in the field wiring.

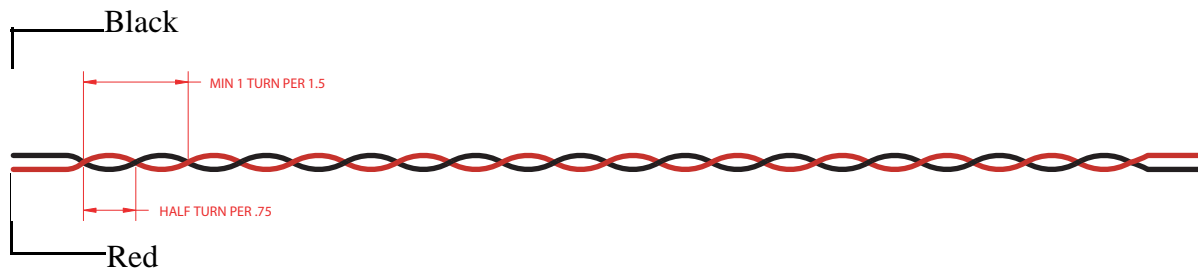

**Twisted pair wire (red and black) for a DC power supply**

---

**Note.** Refer to the wiring diagram for information on connecting the DC power supply to a DC power source.

---

## Connecting to a DC Power Source

The DC power supply on your switch contains a power connector with three (3) square slots for connecting the positive, negative, and ground wires from a DC power source.

### DC Power Connectors

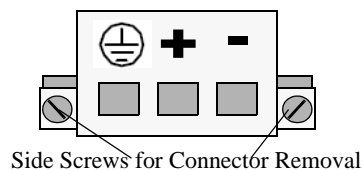

### OmniSwitch DC Power Supply Connector

A clamp inside each slot keeps the power wire tightly in place during operation.

The DC power supply has side screws that can be used to remove the connector if required.

### Installing DC Power Source Wire Leads

These instructions describe how to connect your 3-wire DC power source to the power connector on your DC power supply. A small flat-tip screwdriver and a wire stripper are required for this procedure.

- 1 Prepare the three (3) wires—12 gauge—that will plug into the power supply. First make sure they are not plugged into the DC power source. Next, use a wire stripper to carefully strip between .24 and .29 inches (6-7.5mm) off the end of each wire, removing the outer insulation to expose the copper core.
- 2 Open the clamp for the ground wire slot by inserting a small flat-tip screwdriver into the top of the appropriate circular hole. Loosen the screw so that the clamp for the ground wire opens.

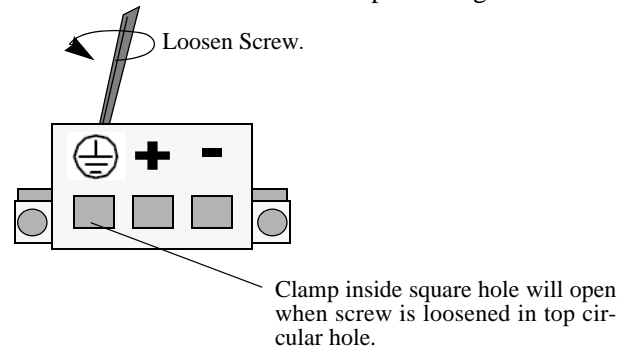

#### Opening Connector for Ground Wire

- 3 Insert the ground wire lead into the slot. The lead you insert *must* match the lead attached to the DC power source.

---

**Warning.** You must plug DC wire leads into the correct holes in the DC power connector. Use the labels above the DC power connector as a guide to positive, negative, and ground connections. If the wire leads are plugged into the wrong holes, the power supply will not work properly and damage to the unit may result.

---

Push the wire in far enough such that it reaches the back wall of the connector, about a half inch inside.

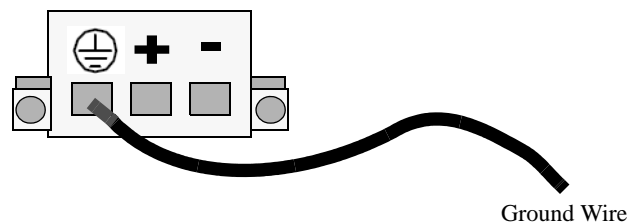

#### Attaching the Ground Wire

**4** Tighten the clamp by tightening the screw above the slot into which you inserted the wire lead. The wire lead should be securely attached inside the connector. You should be able to pull on the wire and not dislodge it.

---

**Warning.** The positive (+) wire of the sourcing equipment, such as a battery or rectifier, must be connected to the positive (+) terminal of the OmniSwitch DC power supply and the negative (-) wire of the sourcing equipment must be connected to the negative (-) terminal of the OmniSwitch DC power supply.

---

**5** Repeat Steps 2 through 4 for the remaining positive and negative wire leads.

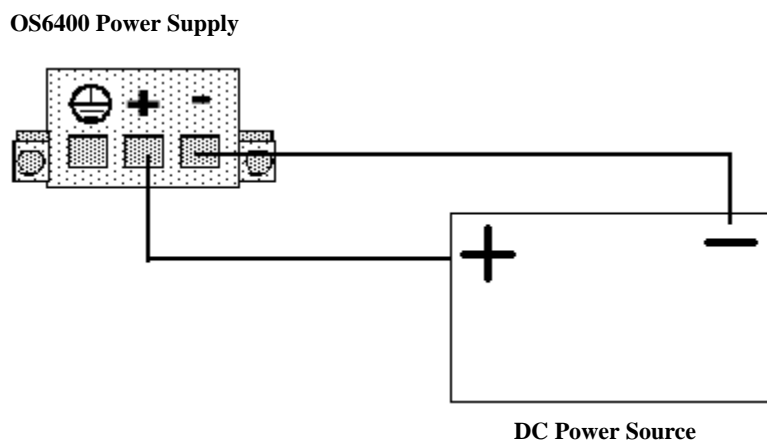

**Correct Polarity Connections**

# Hot-Swapping Power Supplies

OmniSwitch 6400 Series switches support hot-swapping of their power supplies. The following sections describe how to hot-swap a power supply either directly connected (i.e., without a cable) or rack-mounted power supply.

---

**Warning:** Before proceeding, ensure a redundant power supply is connected and operational.

---

**Anti-Static Warning.** Before handling any components, free yourself of static by wearing a grounding strap, or by grounding yourself properly. Static discharge can damage the switch and the backup power supply.

---

## Hot-Swapping a Power Supply Connected to the Rear of the Chassis

- 1 Disconnect the power supply to be hot-swapped from its power source.
- 2 Loosen the captive screw of the power supply to be hot-swapped.
- 3 Carefully slide the power supply out of the power supply shelf and set aside.

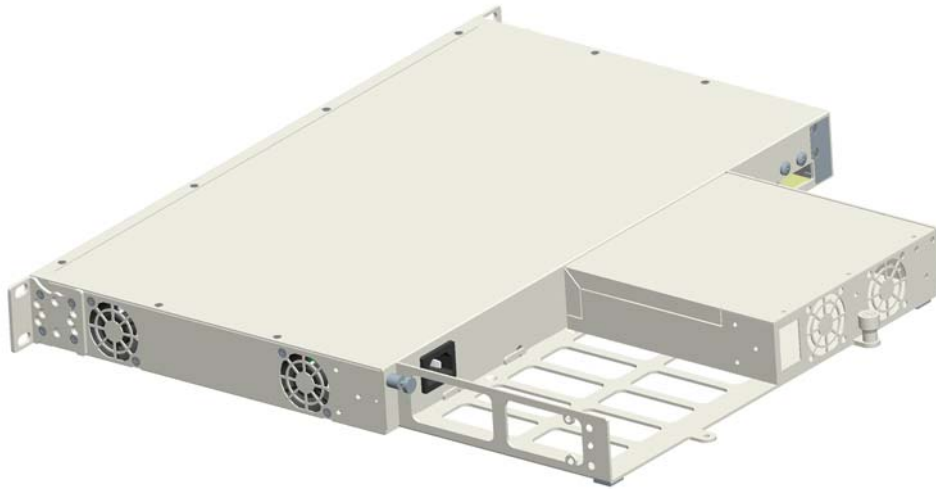

### Directly Connected Power Supply

- 4 Carefully slide the new power supply onto the shelf and against the back of the chassis until the power connector securely connects
- 5 Tighten the captive screw for the new power supply to the power supply shelf.
- 6 Re-connect the power supply to its power source.

## Hot-Swapping a Rack Mounted Power Supply

- 1** Disconnect the power supply to be hot-swapped from its power source.
- 2** Loosen the power supply cable of the power-supply to be hot-swapped and disconnect from power supply.
- 3** Loosen the captive screw of the power supply to be hot-swapped.
- 4** Carefully slide the power supply out of the power supply shelf and set aside.

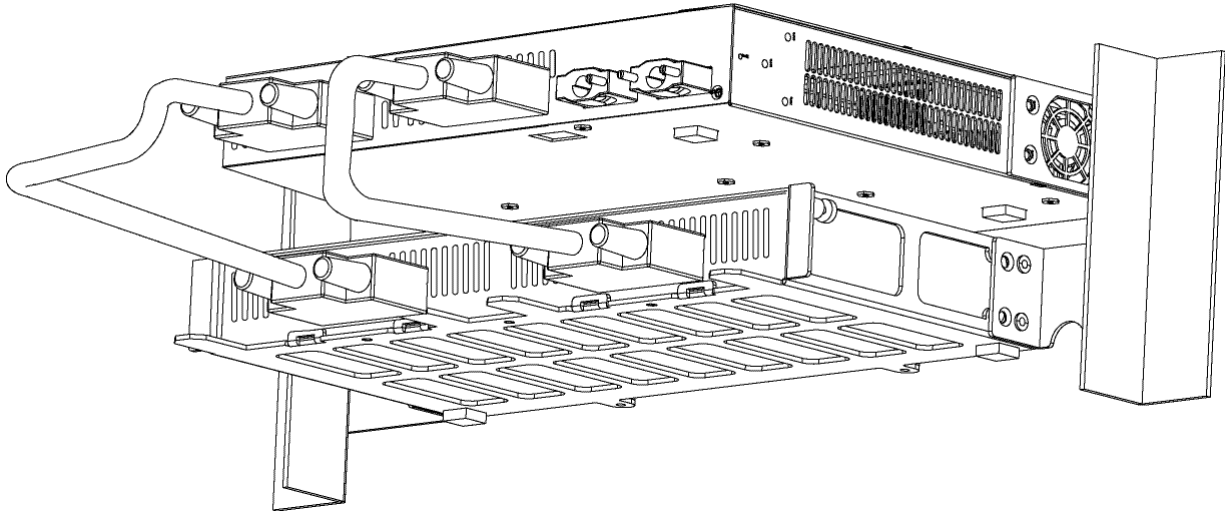

**Rack-Mounted Power Supplies**

- 5** Carefully slide the new power supply on to the power supply shelf and secure the power supply to the shelf using the captive screw.
- 6** Reconnect the power supply cable of the new power-supply and tighten securely.
- 7** Re-connect the power supply to its power source.



# 4 Managing Power over Ethernet (PoE)

Power over Ethernet (PoE) is supported on OmniSwitch 6400 Series switches and provides inline power directly from the switch's Ethernet. Powered Devices (PDs) such as IP phones, wireless LAN stations, Ethernet hubs, and other access points can be plugged directly into the Ethernet. From these RJ-45 the devices receive both electrical power and data flow.

As the feature reduces devices' dependence on conventional power sources, PoE eliminates many restrictions that traditional electrical considerations have imposed on networks.

In a PoE configuration, Power Source Equipment (PSE) detects the presence of a PD and provides an electrical current that is conducted along the data cable. The PD operates using the power received via the Ethernet data cable; no connection to an additional power source (e.g., an AC wall socket) is required.

---

**Note.** There are several general terms used to describe the feature, PoE. The terms *Power over Ethernet (PoE)*, *Power over LAN (PoL)*, *Power on LAN (PoL)*, and *Inline Power* are synonymous terms used to describe the powering of attached devices via Ethernet. For consistency, this chapter and the *CLI Command Reference Guide* refer to the feature as *Power over Ethernet (PoE)*.

Additional terms, such as *Powered Device (PD)* and *Power Source Equipment (PSE)* are not synonymous with PoE, but are directly related to the feature:

- *PD* refers to any attached device that uses a PoE data cable as its only source of power. Examples include access points, such as IP telephones, Ethernet hubs, wireless LAN stations, etc.
- *PSE* refers to power sourcing equipment, which provides power to a single link section. PSE main functions include searching the PD, optionally classifying the PD, supplying power to the link section only if the PD is detected, monitoring the power on the link section, and scaling power back to detect level when power is no longer requested or required.

---

As the OmniSwitch fully supports 10/100/1000 Ethernet connectivity, you may also attach non-PD equipment, such as computer workstations, printers, servers, etc. to the PoE. See [Chapter 2, "OmniSwitch 6400 Series Chassis and Hardware Components."](#) for more information on the OmniSwitch 6400 Series chassis.

---

**Note.** Alcatel-Lucent recommends that PoE-enabled switches with attached IP telephones should have operational power supply redundancy at all times for 911 emergency requirements. In addition, both the switch and the power supply should be plugged into an Uninterruptible Power Source (UPS).

---

## In This Chapter

This chapter provides specifications and descriptions of hardware and software used to provide PoE for attached devices.

The chapter also provides information on configuring PoE settings on the switch through the Command Line Interface (CLI). CLI commands are used in the configuration examples; for more details about the syntax of commands, see the *OmniSwitch CLI Reference Guide*. Topics and configuration procedures described in this chapter include:

- Power over Ethernet Specifications on [page 4-3](#)
- Viewing Power Status on [page 4-4](#)
- Configuring Power over Ethernet Parameters on [page 4-5](#)
- Understanding Priority Disconnect on [page 4-9](#)
- Monitoring Power over Ethernet via the CLI on [page 4-12](#)

---

**Note.** You can also monitor all chassis components and manage many chassis features, including Power over Ethernet, with WebView, Alcatel-Lucent's embedded web-based device management application. WebView is an interactive and easy-to-use GUI that can be launched from the OmniVista or a web browser. Please refer to *WebView's Online Documentation* for more information.

---

## Power over Ethernet Specifications

The table below lists general specifications for Alcatel-Lucent's Power over Ethernet support. For more detailed power supply and Power Source Equipment (PSE) specifications, refer to [Chapter 2, "OmniSwitch 6400 Series Chassis and Hardware Components."](#)

IEEE Standards supported	IEEE 802.3af DTE Power via MDI
Default PoE administrative status	Enabled
Default PoE operational status	Disabled (PoE must be activated on a switch-by-switch basis via the <b>lanpower start</b> command.)
OmniSwitch 6400 Series platforms supporting PoE	OmniSwitch 6400-P24 and OmniSwitch 6400-P48
Cable distances supported	100 meters (approx.)
Total number of PoE-capable ports per switch	24 or 48
Default amount of inline power available for each slot	510W power supply - 390W 360W power supply - 240W
Range of inline power allowed for each slot	510W power supply - 390W 360W power supply - 240W
Default amount of inline power available for each port	15400 milliwatts
Range of inline power allowed for each port	3000–18000 milliwatts

## Viewing PoE Power Supply Status

To view the current status of power supplies installed in the backup power supply, use the **show power** command, as shown below:

```
-> show power
Slot  PS   Wattage   Type   Status   Location
-----+-----+-----+-----+-----+-----
1     1     360      AC     UP       External
1     2     360      AC     UP       External
2     1     510      AC     UP       External
2     2     --       --     --       --
3     1     360      AC     UP       External
3     2     360      AC     DOWN     External
```

### Status Display Output:

UP = Power Supply operational.

DOWN = Power Supply not operational.

-- = Power Supply not present.

# Configuring Power over Ethernet Parameters

## Power over Ethernet Defaults

The following table lists the defaults for PoE configuration:

Parameter Description	Command(s)	Default Value/Comments
PoE operational status	<b>lanpower start</b> or <b>lanpower stop</b>	Disabled
Total power available to a port	<b>lanpower power</b>	“Power over Ethernet Specifications” on page 4-3
Total power available to an entire chassis	<b>lanpower maxpower</b>	“Power over Ethernet Specifications” on page 4-3
Power priority level for a port	<b>lanpower priority</b>	low
Capacitor detection method	<b>lanpower capacitor-detection</b>	Disabled
Priority disconnect status	<b>lanpower priority-disconnect</b>	Enabled

## Understanding and Modifying the Default Settings

The sections below provide information on each of the key components within the Power over Ethernet software. They include information on PoE-related CLI commands. For detailed information on PoE-related commands, refer to the *OmniSwitch CLI Reference Guide*.

**Note.** PoE units support two different power supplies as noted above. If unlike power supplies are mixed or if an unsupported power supply (such as a 120W power supply) is used, a console message and a trap are generated.

## Setting the PoE Operational Status

### Enabling PoE

By default, Power over Ethernet is *administratively enabled* in the switch’s system software. However, in order to physically activate PoE, you must issue the **lanpower start** command on a slot-by-slot basis before any connected PDs will receive inline power.

To activate power to PoE-capable in a switch, enter the corresponding slot number only. For example:

```
-> lanpower start 1
```

If power to a particular port has been disconnected via the **lanpower stop** command, you can reactivate power to the port by specifying both the *slot* and *port* in the command line. For example:

```
-> lanpower start 1/11
```

**Note.** You cannot use the *slot/port* syntax to initially activate PoE on a port. This syntax is intended only to reactivate power to those that have been disconnected via the **lanpower stop** command. To initially activate PoE, you must use the **lanpower start slot** syntax only, as described above.

## Disabling PoE

To disable PoE on a particular slot or port, use the **lanpower stop** command.

To disable PoE on a *specific PoE-capable port*, enter a *slot/port* number. For example:

```
-> lanpower stop 1/22
```

To disable PoE for *all PoE-capable in a slot*, enter the corresponding slot number only. For example:

```
-> lanpower stop 1
```

## Configuring the Total Power Available to a Port

A default amount of milliwatts, as noted in the specifications table, is available for each port on the OmniSwitch. In other words, each port is authorized by the system software to use up to the default amount of milliwatts to power any attached device.

You can either increase or decrease this value based on the ranges listed in the specifications table.

Increasing the total power available to an individual port may provide a more demanding Powered Device (PD) with additional power required for operation. Decreasing the total power available to a port helps to preserve inline power and assists in the overall management of the switch's power budget.

To increase or decrease the total power available to an individual port, use the **lanpower power** command. Since you are setting the power allowance for an individual port, you must specify a *slot/port* number in the command line. For example, the syntax

```
-> lanpower 1/12 power 3000
```

reduces the power allowance on port 1/12 of the OmniSwitch to 3000 milliwatts. This new value is now the maximum amount of power the port can use to power any attached device (until the value is modified by the user).

## Configuring the Total Power Available to a Slot

Like the maximum port power allowance, the system software also provides a maximum *slot-wide* power allowance. Each slot is authorized by the system software to use up to default value of Watts, as noted in the specifications table, to power all devices connected to it depending on which power supply is used.

As with the maximum port power allowance, this value can be either increased or decreased. Values may range from the values listed in the specifications table and are dependent upon the installed power supply.

Increasing the total power available to a slot may provide more demanding Powered Devices (PDs) with additional power required for operation. Decreasing the total power available to a slot helps preserve inline power and assists in the overall management of the switch's power budget.

---

**Important.** Decreasing the slot-wide power could cause lower priority ports to lose power if the new value is less than the total PoE power currently being consumed.

---

To increase or decrease the total power available to a slot, use the **lanpower maxpower** command. Since you are setting the power allowance for an individual slot, you must specify a *slot* number in the command line. For example, the syntax

```
-> lanpower 1 maxpower 80
```

reduces the power allowance of the slot 1 to 80 watts. This value is now the maximum amount of power the slot can use to power all attached devices (until the value is modified by the user).

---

**Note.** Changing the maximum power available to a slot or port **does not** reserve or immediately allocate that power. These settings are only used for configuring a maximum amount of power that may be used, any unused power is still available and remains a part of the overall PoE budget.

---

## Setting Port Priority Levels

As not all Powered Devices (PDs) connected to the switch have the same priority within a customer network setting, the OmniSwitch allow the user to specify priority levels on a port-by-port basis. Priority levels include low, high, and critical. The default priority level for a port is low.

- **Low.** This default value is used for port(s) that have low-priority devices attached. In the event of a power management issue, inline power to low-priority is interrupted first (i.e., before critical and high-priority).
- **High.** This value is used for port(s) that have important, but *not* mission-critical, devices attached. If other in the chassis have been configured as critical, inline power to high-priority is given second priority.
- **Critical.** This value is used for port(s) that have mission-critical devices attached, and therefore require top (i.e., critical) priority. In the event of a power management issue, inline power to critical is maintained as long as possible.

To change the priority level for a particular port, use the **lanpower priority** command. Since the switch allows you to set priority levels on a port-by-port basis, be sure to specify *slot/port* information in the command line. For example, the syntax

```
-> lanpower 1/22 priority critical
```

changes the priority value of port 1/22 to the highest priority level of critical. Now that the default value has been reconfigured, this port should be reserved for those PDs that are mission critical for network operations.

## Setting the Capacitor Detection Method

By default, the PowerDsine capacitor detection method is disabled on an OmniSwitch. To enable it, use the **lanpower capacitor-detection** command by entering **lanpower capacitor-detection** followed by the slot number and **enable**.

For example, to enable the capacitor detection method on the switch with slot number 1, enter:

```
-> lanpower capacitor-detection 1 enable
```

To disable it, use the **lanpower capacitor-detection** command by entering **lanpower capacitor-detection** followed by the slot number and **disable**.

For example, to disable the capacitor detection method on the switch with slot number 1, enter:

```
-> lanpower capacitor-detection 1 disable
```

---

**Note.** The capacitive detection method should only be enabled to support legacy IP phones. This feature is *not* compatible with IEEE specification 802.3af. Please contact your Alcatel-Lucent sales engineer or Customer Support representative to find out which Alcatel-Lucent IP phones models need capacitive detection enabled.

---



# Understanding Priority Disconnect

The priority disconnect function differs from the port priority function described on [page 4-7](#) in that it applies only to *the addition of powered devices (PDs) in tight power budget conditions*. Priority disconnect is used by the system software in determining whether an incoming PD will be granted or denied power when there are too few watts remaining in the PoE power budget for an additional device. For example, if there are only 2 watts available in the current PoE power budget and a user plugs a 3.5W powered device into a PoE port, the system software must determine whether the device will be powered on. Based on priority disconnect rules, in some cases one or more existing devices may be powered down in order to accommodate the incoming device. In other cases, the incoming device will be denied power.

Priority disconnect rules involve the port priority status of an incoming device (i.e., low, high, and critical), as well as the port's physical port number (i.e., 1–24). Understanding priority disconnect rules is especially helpful in avoiding power budget deficits and the unintentional shutdown of mission-critical devices when PDs are being added in tight power budget conditions. For detailed information on how priority disconnect uses port priority and port number criteria for determining the power status of incoming PDs, refer to the examples on pages [4-10](#) through [4-11](#).

---

**Note.** Priority disconnect applies only when there is inadequate power remaining in the power budget for an incoming device.

---

For information on setting the priority disconnect status, refer to the section below. For information on setting the port priority status (a separate function from priority disconnect), refer to [“Setting Port Priority Levels” on page 4-7](#).

## Setting Priority Disconnect Status

By default, priority disconnect is *enabled* in the switch's system software. For information on changing the priority disconnect status, refer to the information below.

### Disabling Priority Disconnect

When priority disconnect is disabled and there is inadequate power in the budget for an additional device, power will be denied to *any* incoming PD, regardless of its port priority status (i.e., low, high, and critical) or physical port number (i.e., 1–24).

To disable priority disconnect, use the [lanpower priority-disconnect](#) command. Since the switch allows you to set priority disconnect status on a slot-by-slot basis, be sure to specify the slot number in the command line. For example, the syntax

```
-> lanpower 1 priority-disconnect disable
```

disables the priority disconnect function on slot 1.

### Enabling Priority Disconnect

To enable priority disconnect, use the [lanpower priority-disconnect](#) command. Be sure to specify the slot number in the command line. For example, the syntax

```
-> lanpower 1 priority-disconnect enable
```

enables priority disconnect on slot 1.

---

## Priority Disconnect is Enabled; Same Priority Level on All PD

---

**Note.** Priority disconnect examples are applicable only when there is inadequate power remaining to power an incoming device.

---

When a PD is being connected to a port with the *same priority level* as all other in the slot, the physical port number is used to determine whether the incoming PD will be granted or denied power. Lower-numbered receive higher priority than higher-numbered. In other words, a PD connected to Port 1 will have a higher power priority than a PD connected to Port 2; a PD connected to Port 23 will have a higher power priority than a PD connected to Port 24. In order to avoid a power budget deficit, another port in the slot is disconnected. In determining which port to power off, the system software disconnects the port with the highest physical port number.

---

## Priority Disconnect is Enabled; Incoming PD Port has Highest Priority Level

---

**Note.** Priority disconnect examples are applicable only when there is inadequate power remaining to power an incoming device.

---

When a PD is being connected to a port with a *higher priority level* than all other in the slot, the incoming PD will automatically be granted power over the other devices, regardless of its physical port number.

In order to avoid a power budget deficit, another port in the slot is disconnected. In determining which port to power off, the system software first selects the port with the lowest configured priority level. For example, if a *critical priority* device is being added to a slot in which five existing devices are attached to *high priority* and one device is attached to a *low priority* port, the low priority port is automatically disconnected, regardless of its physical port number.

If all existing devices are attached with the same lower priority level, the system software disconnects the port with both the lowest priority level *and* the highest physical port number. For example, if a critical priority device is being added to a slot in which six existing devices are attached to high priority, the high priority port with the highest physical port number is automatically disconnected.

---

## Priority Disconnect is Enabled; Incoming PD Port has Lowest Priority Level

---

**Note.** Priority disconnect examples are applicable only when there is inadequate power remaining to power an incoming device.

---

When a PD is being connected to a port with a *lower priority level* than all other in the slot, the incoming PD will be denied power, regardless of its physical port number. Devices connected to other higher-priority will continue operating without interruption.

## Priority Disconnect is Disabled

---

**Note.** Priority disconnect examples are applicable only when there is inadequate power remaining to power an incoming device.

---

When priority disconnect is disabled, power will be denied to *any* incoming PD, regardless of its port priority status (i.e., low, high, and critical) or physical port number (i.e., 1–24).

## Monitoring Power over Ethernet via CLI

To monitor current PoE statistics and settings, use the **show lanpower** command. The command output displays a list of all current PoE-capable, along with the following information for each port:

- Maximum power available to the port, in milliwatts
- Actual power used by the port
- Current port status
- Power priority status
- Power on/off status

Aggregate slot and chassis management information is also displayed. This information includes:

- Maximum watts available to the corresponding slot
- Amount of power budget remaining for PoE modules
- Total amount of power remaining that for additional switch functions

When entering the **show lanpower** command, you must include a valid slot number in the command line syntax. For example:

```
-> show lanpower 1
Port Maximum(mW) Actual Used(mW) Status Priority On/Off
-----+-----+-----+-----+-----+-----+
 1      16000          0      Undefined      Low      OFF
 2      16000          0      Undefined      Low      OFF
 3      16000          0      Undefined      Low      OFF
 4      16000          0      Undefined      Low      OFF
 5      16000          0      Undefined      Low      OFF
 6      16000          0      Undefined      Low      OFF
 7      16000          0      Undefined      Low      OFF
 8      16000          0      Undefined      Low      OFF
 9      16000          0      Undefined      Low      OFF
10      16000          0      Undefined      Low      OFF
11      16000          0      Undefined      Low      OFF
12      16000          0      Undefined      Low      OFF
13      16000          0      Undefined      Low      OFF
14      16000          0      Undefined      Low      OFF
15      16000          0      Undefined      Low      OFF
16      16000          0      Undefined      Low      OFF
17      16000          0      Undefined      Low      OFF
18      16000          0      Undefined      Low      OFF
19      16000          0      Undefined      Low      OFF
20      16000          0      Undefined      Low      OFF
21      16000          0      Undefined      Low      OFF
22      16000          0      Undefined      Low      OFF
23      16000          0      Undefined      Low      OFF
24      16000          0      Undefined      Low      OFF
25      16000          0      Undefined      Low      OFF
26      16000          0      Undefined      Low      OFF
27      16000          0      Undefined      Low      OFF
28      16000          0      Undefined      Low      OFF
```

*(Output continued on next page)*

---

29	16000	0	Undefined	Low	OFF
30	16000	0	Undefined	Low	OFF
31	16000	0	Undefined	Low	OFF
32	16000	0	Undefined	Low	OFF
33	16000	0	Undefined	Low	OFF
34	16000	0	Undefined	Low	OFF
35	16000	0	Undefined	Low	OFF
36	16000	0	Undefined	Low	OFF
37	16000	0	Undefined	Low	OFF
38	16000	0	Undefined	Low	OFF
39	16000	0	Undefined	Low	OFF
40	16000	0	Undefined	Low	OFF
41	16000	0	Undefined	Low	OFF
42	16000	0	Undefined	Low	OFF
43	16000	0	Undefined	Low	OFF
44	16000	0	Undefined	Low	OFF
45	16000	0	Undefined	Low	OFF
46	16000	0	Undefined	Low	OFF
47	16000	0	Undefined	Low	OFF
48	16000	0	Undefined	Low	OFF

Slot 1 Max Watts 410  
410 Watts Total Power Budget Remaining  
410 Watts Total Power Budget Available  
1 Power Supplies Available

---

**Note.** For detailed information on **show lanpower** command output, refer to the *OmniSwitch CLI Reference Guide*.

---



# 5 Managing OmniSwitch 6400 Series Stacks

In addition to their working as individual stand-alone switches, OmniSwitch 6400 Series switches can also be linked together to work as a single virtual chassis known as a *stack*. With stacks, users can easily expand their switching capacity simply by adding additional switches to the stack. In addition, stacks provide enhanced resiliency and redundancy features. For more information, refer to [page 5-3](#).

---

**Note.** See [Chapter 2, “OmniSwitch 6400 Series Chassis and Hardware Components,”](#) for information on managing OmniSwitch 6400 Series switches in a stand-alone configuration.

---

---

**Note.** Other stackable Alcatel-Lucent products, such as the OmniSwitch 6850, *cannot* be added to a stacked OmniSwitch 6400 Series virtual chassis.

---

## In This Chapter

This chapter provides information on OmniSwitch 6400 Series switches configured to operate as a single virtual chassis. Topics described in the chapter include:

- OmniSwitch 6400 Series stack overview on [page 5-3](#).
- Roles within the stack on [page 5-3](#).
- Stack Redundancy on [page 5-16](#).
- Slot numbering on [page 5-18](#).
- Hot-Swapping modules in a stack on [page 5-23](#).
- Reloading switches on [page 5-25](#).
- Changing the secondary module to primary on [page 5-33](#).
- Synchronizing switches in a stack on [page 5-35](#).
- Monitoring the stack on [page 5-36](#).

---

**Note.** You can also manage and monitor OmniSwitch 6400 Series stacks through WebView, Alcatel-Lucent's embedded web-based device management application. WebView is an interactive and easy-to-use GUI that can be launched from OmniVista or a web browser. Please refer to WebView's online documentation for more information.

---



# OmniSwitch 6400 Series Stack Overview

Users can configure up to eight OmniSwitch 6400 Series switches, in any combination of OS6400-24 and OS6400-48 chassis types, into a single virtual chassis known as a *stack*. With stacks, switching capacity can be easily expanded simply by adding additional switches to the stack. For example, a user can start with a stack composed of two switches and add up to six additional switches to that stack as network demands increase over time.

---

**Note.** Switches should be added one at a time in a stack.

---

Stacks also provide enhanced resiliency and redundancy features. If a switch in a stack goes down or is taken offline, the other elements in the stack will continue to operate without disruption. In addition, when a switch auto-synchronizes at boot-up, or if the user manually synchronizes the switches (see [“Synchronizing Switches in a Stack” on page 5-35](#) for more information), operating software and configuration parameters are backed up on all switches in the stack. As a result, the original operating software and configuration parameters can be easily recovered if corrupted or otherwise lost.

---

**Note on Terminology.** In the user guides provided with your OmniSwitch 6400 Series switch, the terms *stack* and *virtual chassis* are interchangeable referring to OmniSwitch 6400 Series switches in a stacked configuration. The terms *module*, *switch*, *slot*, and *element* are used to refer to individual switches within a stacked configuration. The terms *Chassis Management Module (CMM)* and *management module* refer to those switches operating in a stack either in the primary or secondary management roles. OmniSwitch 6400 Series switches operating in an idle role are essentially acting as network interface modules and therefore may be referred to as *Network Interfaces (NIs)*.

---

## Roles Within the Stack

In order to operate as a virtual chassis, switches within an OmniSwitch 6400 Series stack are assigned specific roles. These roles include primary and secondary management roles, idle status, and pass-through. For detailed descriptions of each of these roles, including their practical functions within the virtual chassis, refer to the sections below.

### Primary and Secondary Management Modules

When OmniSwitch 6400 Series switches operate in a stack, one switch in the stack always assumes the *primary management* role. This primary element is responsible for functions, such as software and configuration management, web-based management (i.e., WebView), SNMP management, switch diagnostics, and software rollback.

One additional switch in the stack operates in a *secondary management* role. This switch serves as a backup, and is always ready to assume the primary management role in the stack if the switch with the primary role fails or is taken offline for any reason.

Since the secondary module quickly and automatically assumes management responsibilities, switches operating in idle mode elsewhere in the stack continue to pass traffic without disruption. This redundancy provides effective safeguards for mission-critical network traffic and is one of the stack's most important failover features. Diagrams showing the management module failover sequence for stacks of three or more switches and stacks of two switches are provided on pages [5-4](#) and [5-5](#), respectively.

**Important Note.** For management module redundancy to work effectively, the software on all switches operating in the stack must be synchronized at all times. Refer to [“Synchronizing Switches in a Stack”](#) on page 5-35 for more information.

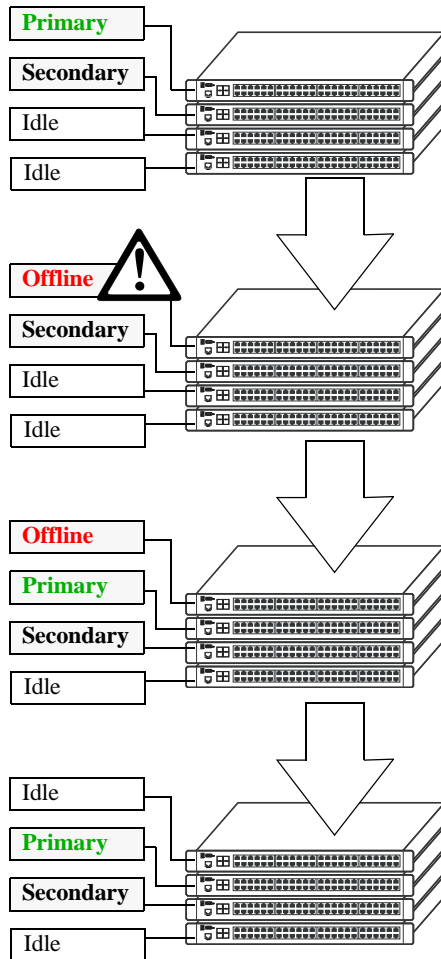

- 1 A stack of four OmniSwitch 6400 Series switches is operating normally. The stack consists of a primary module, secondary module, and two elements operating in idle status. (The software on all elements in the stack is synchronized.)
- 2 The primary management module in the stack fails or is taken offline (e.g., powered off or rebooted by the user).
- 3 The switch operating as the secondary management module immediately takes over the primary role. Meanwhile, the adjacent switch—previously operating in idle status—now assumes the secondary management role.
- 4 If the switch that failed or was taken offline comes back online, it will assume an idle role in the stack. In other words, it will act essentially as an NI module in the virtual chassis, passing traffic via its Ethernet.

### Redundant Management Module Failover (Three or More Switches)

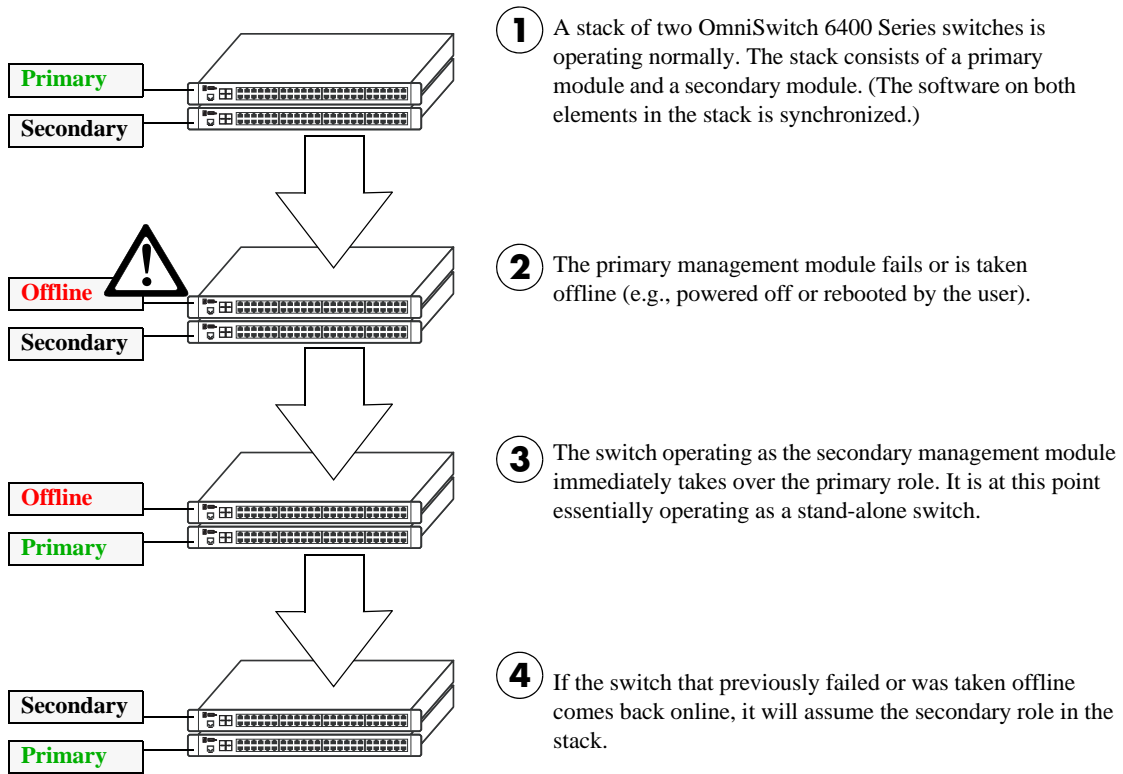

**Redundant Management Module Failover (Two Switches)**

## Primary Management Module Selection

For a stack of OmniSwitch 6400 Series switches to operate as a virtual chassis, there must be a mechanism for dynamically selecting the switch within the stack that will assume the primary management role. OmniSwitch 6400 Series switches use three different methods for selecting the primary switch. These methods are:

- Chassis MAC address
- Saved slot number
- Chassis uptime

---

**Note.** Information on *secondary management module* selection is provided on [page 5-9](#). Information on dynamic assignment of *idle module* roles is provided on [page 5-11](#).

---

### Using the Chassis MAC Address

By default, the primary management role will be given to the switch with the lowest chassis MAC address. However, for this to occur, all switches in the stack *must be booted within 15 seconds of each other*. In addition, switches in the stack *must have no preconfigured slot information*. Because of these two conditions, the MAC address method for selecting the primary module usually occurs with new “out of the box” switches, or switches from which any preconfigured slot information has been cleared.

For more information on using the lowest MAC address to determine the primary switch in a stack, refer to the diagram below:

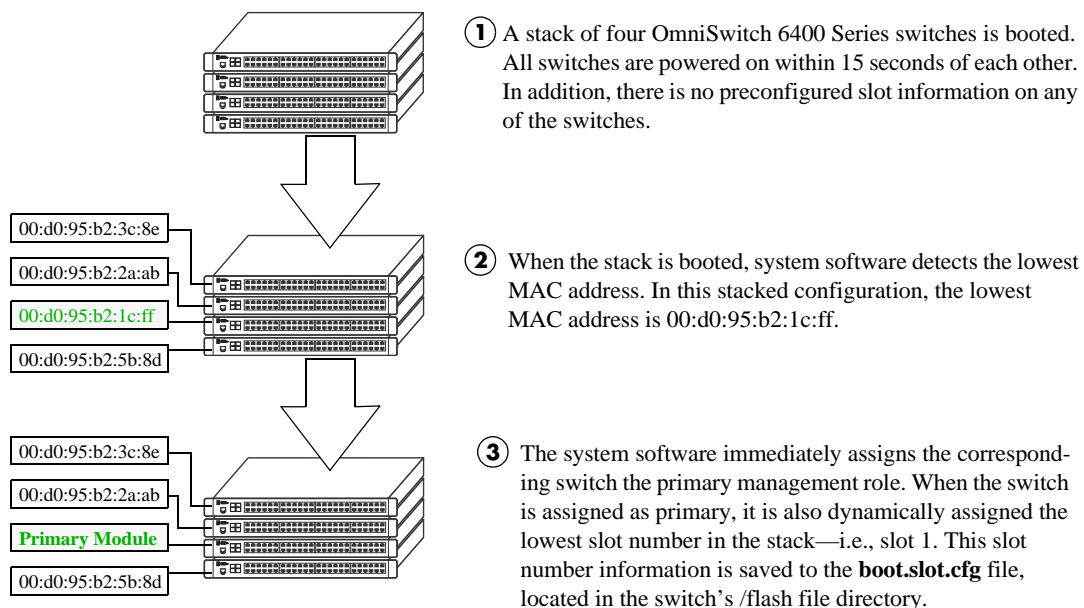

### Primary Management Module Selection Using the Lowest Chassis MAC Address

---

**Note.** During the boot process, all other switches in the stack are also dynamically assigned unique slot numbers. As with the primary switch, these slot numbers are saved to the `boot.slot.cfg` file, located in the `/flash` file directory of each switch. For more information on dynamic slot number assignment, refer to “Slot Numbering” on [page 5-18](#).

---

## Using Saved Slot Information

The saved slot number is the slot number the switch will assume following a reboot. This information is stored in a switch's **boot.slot.cfg** file; the switch reads its slot number assignment from this file at bootup and assumes the specified slot number within the stack.

If switches in a stacked configuration have no preconfigured slot assignments, the slot number for each switch is dynamically assigned by the system software. Slot numbers can also be manually assigned by the user. For more information on manually assigning slot numbers, refer to [“Manual Slot Number Assignment” on page 5-21](#).

When a stack with preconfigured slot information is booted, it is *not* the lowest MAC address that determines the primary management module. Instead, the slot information stored in each switch's **boot.slot.cfg** is read by the system software and used in determining the primary. The switch with the lowest saved slot number becomes the primary management module.

---

**Note.** Although, for ease-of-management purposes, it is recommended that slot numbers are assigned beginning with slot number 1, it is not a requirement. In other words, a stack of four switches can have slot assignments 3, 4, 5, and 6. However, it is important that each element in a stack is assigned a *unique* slot number. Do not assign duplicate slot numbers to elements in a stack. Otherwise, one or more switches will be forced into pass-through mode. For more information on pass-through mode, refer to [page 5-12](#).

---

For more information on using saved slot information to determine the primary switch in a stack, refer to the diagram below:

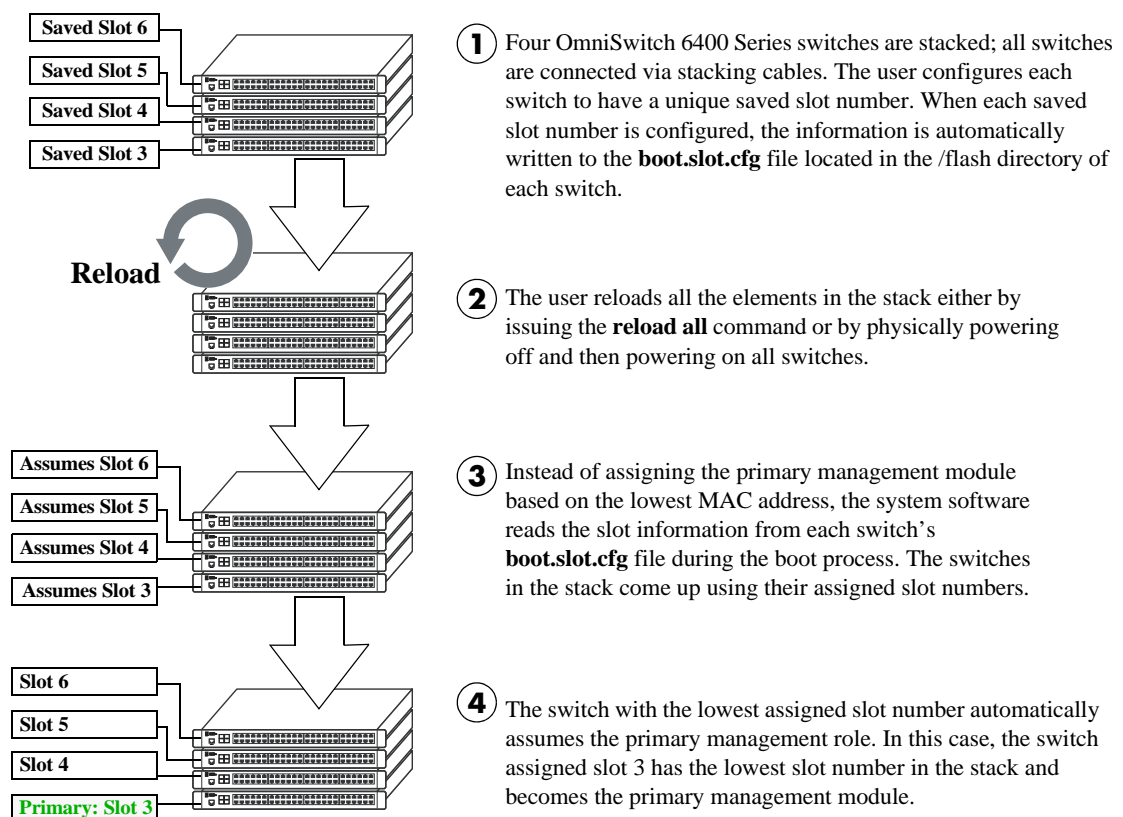

**Primary Management Module Selection Using Saved Slot Information**

## Using Switch Uptime

A user can override both the MAC address and saved slot methods for determining a stack's primary management module. This is done by controlling the uptime of switches in the stack. If all elements of a stack are powered off, the user can force a particular switch to become primary by powering on that switch and waiting a minimum of 15 seconds before powering on any other switches. This can be useful if the user wants a switch placed in a specific location, e.g., the top-most switch in a stack, to become the primary.

As with the lowest MAC address method, the primary management module is dynamically assigned slot number 1 when the stack is booted.

For more information on using saved slot information to determine the primary switch in a stack, refer to the diagram below:

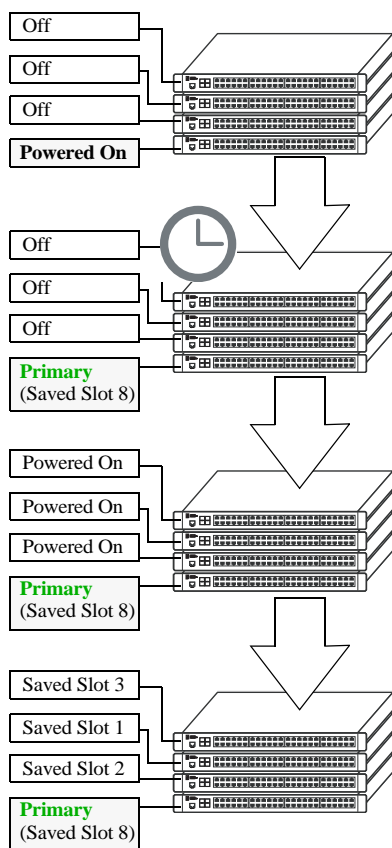

- 1 Four OmniSwitch 6400 Series switches are stacked and connected via stacking cables. All switches are currently powered off. The user powers on a single switch in the stack. In this case, the bottom-most switch is powered on.
- 2 The user allows a minimum of 15 seconds to pass. Because no other switches have joined the stack, the switch that was powered on considers itself a stand-alone. The switch assumes a primary role by default—even if there is a high saved slot number in its `boot.slot.cfg` file (e.g., 8).
- 3 The user now powers on the remaining switches in the stack in short succession.
- 4 In this example, when the remaining switches come online, each has a lower saved slot value than the switch powered on at step 1. However, the switch powered on at step 1—with its slot value of 8—retains its primary management role. The joining switches are essentially ineligible for primary status because they are considered “late arrivals.”

For the primary switch to forfeit its role to the switch with the lowest assigned slot number (in this case, slot number 1), the stack must be rebooted by the user either by issuing the `reload all` command or by powering off and powering on all switches in close succession.

### Primary Management Module Selection Using Switch Uptime

## Secondary Management Module Selection

In order to provide effective management module redundancy, all OmniSwitch 6400 Series stacked configurations dynamically assign a backup, or secondary, management module during the boot process. OmniSwitch 6400 Series stacks use two different methods for selecting the secondary switch. These methods are:

- Stacking connection to the primary switch
- Saved slot number

### Using the Stacking Connection to the Primary Switch

By default, the switch that is connected to the primary switch’s stacking port A is automatically assigned the secondary management role. This applies to stacks on which there is no preassigned slot information—i.e., there is no `boot.slot.cfg` file present in any switch.

For more information on using the stacking connection to the primary switch to determine the secondary management module, refer to the diagram below:

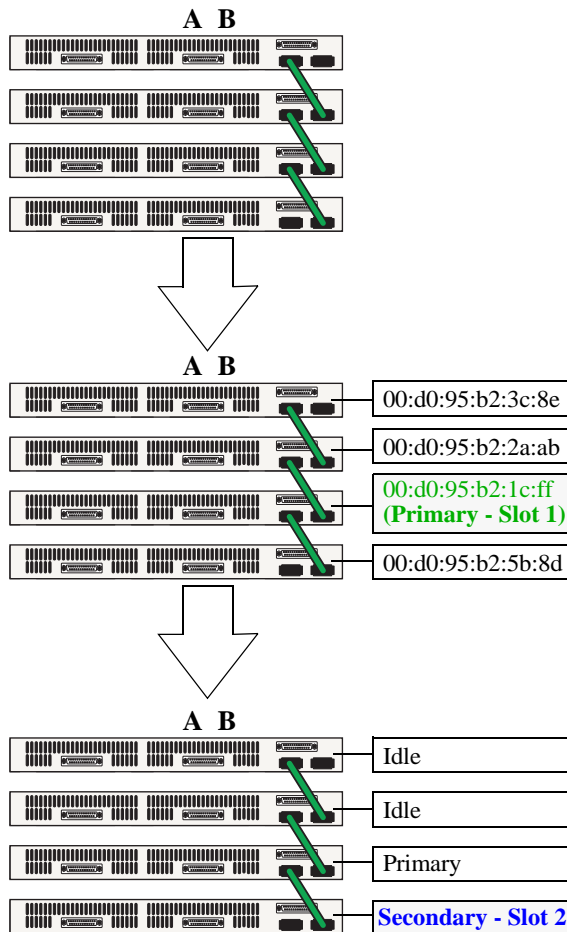

① Four OmniSwitch 6400 Series switches are stacked and connected via stacking cables, as shown. All switches are currently powered off. None of the switches have preassigned slot numbers—i.e., there are no `boot.slot.cfg` files present. The user powers on all switches in the stack in close succession and the stack begins the boot process.

② When the elements in the stack come online, the switch with the lowest MAC address is given the primary management role and is dynamically assigned slot number 1.

③ By default, the switch connected to the primary’s stacking port A is automatically assigned the secondary management role. The secondary switch is dynamically assigned slot number 2.

### Secondary Management Module Selection Using the Stacking Connection to the Primary Switch

**Note.** For information on dynamic slot numbering for idle elements within the stack, refer to [“Idle Module Role” on page 5-11](#) and [“Slot Numbering” on page 5-18](#).

## Using Saved Slot Information

If a stack with preassigned slot information for each switch is booted, the switch with the *second lowest* slot value is assigned the secondary management role. For example, if a stack of four switches is booted and the preassigned slot values for each switch are 1, 2, 3, and 4, the switch with the slot value of 2 is assigned the secondary role. Meanwhile, the switch with the slot value of 1 is assigned the primary management role (see [page 5-7](#)).

For more information on using saved slot information to determine the secondary management module in a stack, refer to the diagram below:

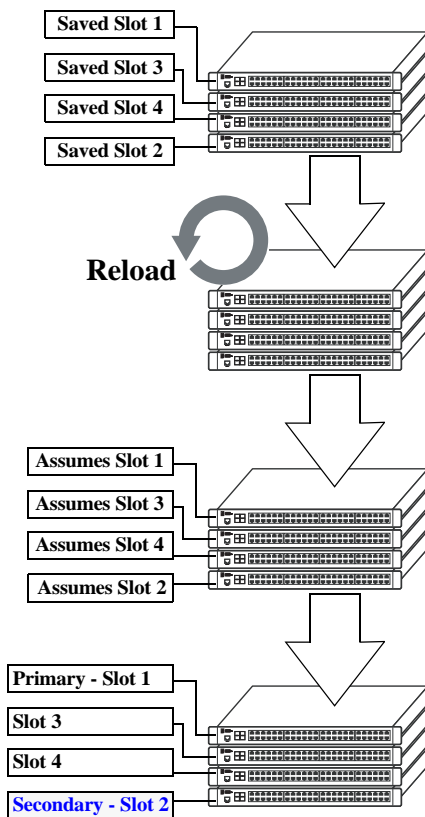

- 1 Four OmniSwitch 6400 Series switches are stacked; all switches are connected via stacking cables. The user configures each switch to have a unique saved slot number, as shown. When the saved slot number is configured, the information is automatically written to the `boot.slot.cfg` file located in the `/flash` directory of each switch.
- 2 The user reloads all the elements in the stack either by issuing the `reload all` command or by physically powering off and then powering on all switches.
- 3 The system software reads the slot information from each switch's `boot.slot.cfg` file during the boot process. The switches in the stack come up using their assigned slot numbers.
- 4 The switch with the lowest assigned slot number automatically assumes the primary management role. The switch with the *second lowest* assigned slot number becomes the secondary management role, regardless of whether it is attached to stacking port A of the primary switch. In this case, the switch assigned slot 2 has the second-lowest slot number in the stack and becomes the secondary management module.

### Secondary Management Module Selection Using Saved Slot Information

---

**Reminder.** Each element in a stack should always be assigned a *unique* slot number. Do not assign duplicate slot numbers to elements in a stack. Otherwise, one or more switches will be forced into pass-through mode. For more information on pass-through mode, refer to [page 5-12](#).

---



## Idle Module Role

Switches that are not assigned either the primary or secondary role in a stack are, by default, assigned the role of *idle* modules. These idle modules operate similarly to Network Interface (NI) modules in a chassis-based switch such as the OmniSwitch 9700/9800. It is the job of idle modules to send and receive 10/100/1000 Ethernet traffic on their.

In the event of a management module failure within the stack, the idle module with the next lowest slot number in the stack will automatically assume the secondary management role. In other words, if the primary module in a stack goes down for any reason and the secondary takes over the primary management role, the switch must now assign a new secondary module. The idle element with the next lowest slot number assumes this new responsibility until the situation is corrected and all elements in the stack are reloaded.

---

**Note.** Primary and secondary management modules also send and receive 10/100/1000 traffic on their Ethernet. The primary management module is like an NI module with the added task of overall stack management; the secondary management module is like an NI with the added responsibility of backing up the primary module in the event of a primary module failure. In other words, *all modules* in the virtual chassis can send and receive user data, regardless of their roles.

---

For more information on dynamic assignment of idle modules in a stack, refer to the diagram below:

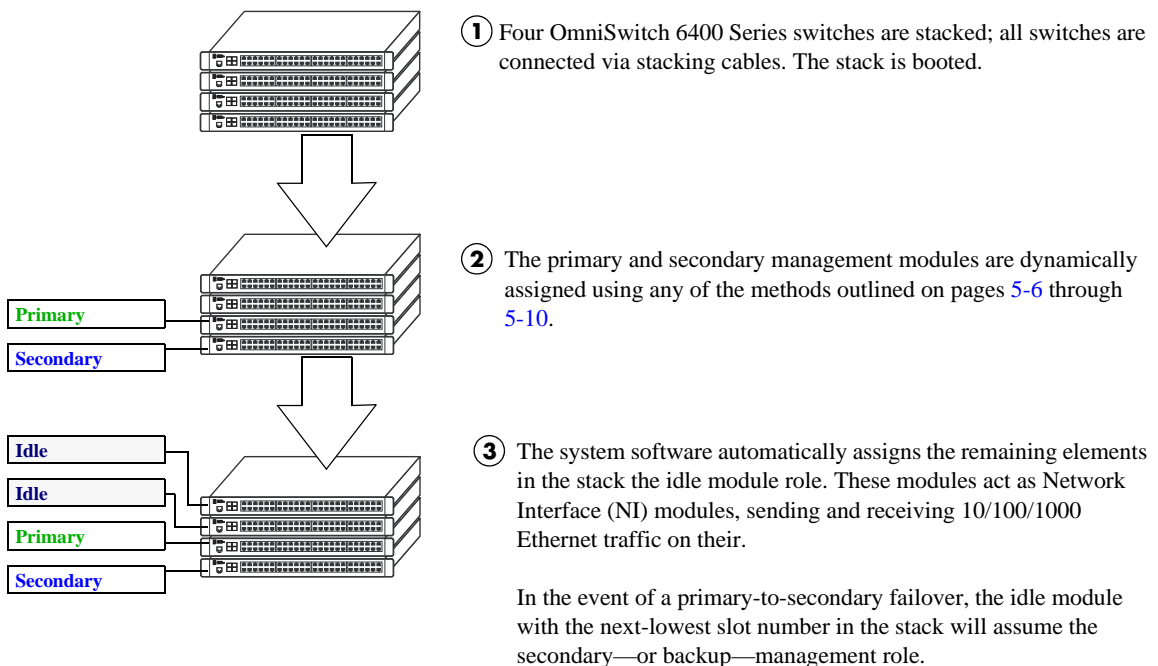

### Secondary Management Module Selection Using Saved Slot Information

## Pass-Through Mode

The pass-through mode is a state in which a switch has attempted to join a stack but has been denied primary, secondary, and idle status. When a switch is in the pass-through mode, its Ethernet are brought down (i.e, they cannot pass traffic). Its stacking cable connections remain fully functional and can pass traffic through to other switches in the stack. In this way, the pass-through mode provides a mechanism to prevent the stack ring from being broken. However, note that when a switch comes up in pass-through mode, it should not be left unresolved. Pass-through mode is essentially an error state that should be corrected immediately by the user.

---

**Note.** When a switch is in pass-through mode, its information will not display in hardware monitoring commands such as **show chassis**, **show ni**, **show module**, etc.

---

Conditions that can trigger a switch to enter pass-through mode include:

- Duplicate slot numbers have been assigned within the stack
- The user has manually forced the switch into pass-through mode using the **stack clear slot** command

---

**Note.** If a switch is forced into pass-through mode, the rest of the stack will not be disrupted. Any elements in the stack *not* operating in pass-through mode continue to operate normally.

---

The most common reason for one or more switches to enter pass-through is duplicate slot number assignments within the stack. So, in order to avoid pass-through mode, it is useful to keep track of the current saved slot numbers on all elements in the stack. Slot number assignments are stored in the **boot.slot.cfg** file in the /flash directory of each switch.

If the stack is booted and the same slot number is discovered on two or more switches, the switch with the lowest MAC address is allowed to come up and operate normally. Meanwhile, switches with the duplicate slot number *and* a higher MAC address come up in pass-through mode. To check the current slot number stored in each switch's **boot.slot.cfg** file, use the **show stack topology** command. For example:

```
-> show stack topology
```

NI	Role	State	Saved Slot	Link A State	Link A Remote NI	Link A Remote Port	Link B State	Link B Remote NI	Link B Remote Port
1	PRIMARY	RUNNING	1	UP	3	StackA	UP	2	StackA
2	SECONDARY	RUNNING	2	UP	1	StackB	UP	3	StackB
3	IDLE	RUNNING	2	UP	1	StackA	UP	2	StackB

In this example, note that both slots 2 and 3 have a saved slot value of 2. If this stack is rebooted, a duplicate slot error will occur and the switch with the lower MAC address will be given the secondary management role. The slot with the higher MAC address will be forced into the pass-through mode.

To avoid a pass-through condition following a reboot, make sure that all saved slot values for the stack are unique. Use the **stack set slot** command. For example, change the saved slot value for the idle switch in slot 3 from 2 to 3:

```
-> stack set slot 3 saved-slot 2
```

Use the **show stack topology** command to verify the change:

```
-> show stack topology
```

NI	Role	State	Saved Slot	Link A State	Link A Remote NI	Link A Remote Port	Link B State	Link B Remote NI	Link B Remote Port
1	PRIMARY	RUNNING	1	UP	3	StackA	UP	2	StackA
2	SECONDARY	RUNNING	2	UP	1	StackB	UP	3	StackB
3	IDLE	RUNNING	3	UP	1	StackA	UP	2	StackB

## Recovering from Pass-Through Mode (Duplicate Slot Numbers)

The first step in recovering from pass-through is to determine which modules are currently operating in pass-through, as well as the reason for the pass-through state. To view this information, use the **show stack topology** command. For example:

```
-> show stack topology
```

NI	Role	State	Saved Slot	Link A State	Link A Remote NI	Link A Remote Port	Link B State	Link B Remote NI	Link B Remote Port
1	PRIMARY	RUNNING	1	UP	1001	StackA	UP	2	StackA
2	SECONDARY	RUNNING	2	UP	1	StackB	UP	1001	StackB
1001	PASS-THRU	DUP-SLOT	2	UP	1	StackA	UP	2	StackB

Switches operating in pass-through mode are given distinct slot numbers. These slot numbers are not related to their position in the stack. Instead, they are assigned the prefix “100,” followed by the numerical order in which they were forced into pass-through (1001–1008).

---

**Note.** For pass-through elements 1001 through 1008, the slot indicator LED on the chassis front panel blinks 1 through 8, respectively. For example, if a module enters pass-through and has the slot number 1004, the LED for the module blinks the number 4. For more information on the slot indicator LED, refer to [“LED Status Indicators” on page 2-20](#).

---

In the example above, the switch with the NI (i.e., slot) number 1001 is operating in pass-through. Note that the role assignment is PASS-THRU; also, the state displays DUP-SLOT, or *duplicate slot number*. This can be further verified by looking down the saved slot column in the table. Note that slot 2, operating in the secondary management role, has a saved slot value of 2. Slot 1001, operating in pass-through, also has a saved slot value of 2.

To resolve this pass-through condition, simply assign slot 1001 a new saved slot value and reboot the module. This can be done in either of two ways:

- Use the **stack set slot** command to assign the new value, then use the **reload pass-through** command to reboot the module:

```
-> stack set slot 1001 saved-slot 3
-> reload pass-through 1001
```

- Use the **stack set slot** command to assign the new slot value and, using the optional **reload** syntax in the command line, reboot the module:

```
-> stack set slot 1001 saved-slot 3 reload
```

When the module comes up, it assumes the new, unique slot position—in this case, slot 3—and, because it now has the highest slot number in the stack, it assumes an idle role (leaving the primary and secondary roles to slots 1 and 2, respectively). There are now no duplicate numbers in the stack and all elements are operating normally:

```
-> show stack topology
```

NI	Role	State	Saved Slot	Link A State	Link A Remote NI	Link A Remote Port	Link B State	Link B Remote NI	Link B Remote Port
1	PRIMARY	RUNNING	1	UP	3	StackA	UP	2	StackA
2	SECONDARY	RUNNING	2	UP	1	StackB	UP	3	StackB
3	IDLE	RUNNING	3	UP	1	StackA	UP	2	StackB

In some pass-through conditions (for example, larger stacks where multiple switches are in pass-through mode), it might be desirable to correct any duplicate saved slot assignments and then reboot the entire stack. The recovery from pass-through can be accomplished with fewer steps than reassigning slot numbers and rebooting modules on a slot-by-slot basis. However, be sure that there is no mission-critical traffic being passed on the non-pass-through modules; traffic will be interrupted on these modules during the reboot.

The following example shows a large stack with multiple elements operating in pass-through mode:

```
-> show stack topology
```

NI	Role	State	Saved Slot	Link A State	Link A Remote NI	Link A Remote Port	Link B State	Link B Remote NI	Link B Remote Port
4	IDLE	RUNNING	4	UP	5	StackB	UP	3	StackA
5	IDLE	RUNNING	5	UP	1001	StackB	UP	4	StackA
1001	PASS-THRU	DUP-SLOT	2	UP	2	StackB	UP	5	StackA
2	SECONDARY	RUNNING	2	UP	1003	StackB	UP	1001	StackA
1003	PASS-THRU	DUP-SLOT	2	UP	1002	StackB	UP	2	StackA
1002	PASS-THRU	DUP-SLOT	2	UP	1	StackB	UP	1003	StackA
1	PRIMARY	RUNNING	1	UP	3	StackB	UP	1002	StackA
3	IDLE	RUNNING	3	UP	4	StackB	UP	1	StackA

This disordered stack topology, with its three modules operating in pass-through mode, can be corrected by entering the following commands:

```
-> stack set slot 4 saved-slot 1
-> stack set slot 5 saved-slot 2
-> stack set slot 1001 saved-slot 3
-> stack set slot 2 saved-slot 4
-> stack set slot 1003 saved-slot 5
-> stack set slot 1002 saved-slot 6
-> stack set slot 1 saved-slot 7
-> stack set slot 3 saved-slot 8
-> reload all
```

When all elements in the stack come up following the reboot, there are no longer any duplicate slot numbers in the stack. In addition, the stack topology is more orderly and, as a result, easier to manage:

```
-> show stack topology
```

NI	Role	State	Saved Slot	Link A State	Link A Remote NI	Link A Remote Port	Link B State	Link B Remote NI	Link B Remote Port
1	PRIMARY	RUNNING	1	UP	2	StackB	UP	8	StackA
2	SECONDARY	RUNNING	2	UP	3	StackB	UP	1	StackA
3	IDLE	RUNNING	3	UP	4	StackB	UP	2	StackA
4	IDLE	RUNNING	4	UP	5	StackB	UP	3	StackA
5	IDLE	RUNNING	5	UP	6	StackB	UP	4	StackA
6	IDLE	RUNNING	6	UP	7	StackB	UP	5	StackA
7	IDLE	RUNNING	7	UP	8	StackB	UP	6	StackA
8	IDLE	RUNNING	8	UP	1	StackB	UP	7	StackA

# Stack Redundancy and Failover

**Important.** For a stacked configuration to have effective redundancy, a redundant stacking cable must be installed between the upper-most and bottom-most switch in the chassis at all times.

The figure below shows how the redundant connection between the top and bottom switches in the stack ensures that data will continue to flow throughout the stack, even in the event of a connection failure at one of the stacking cables.

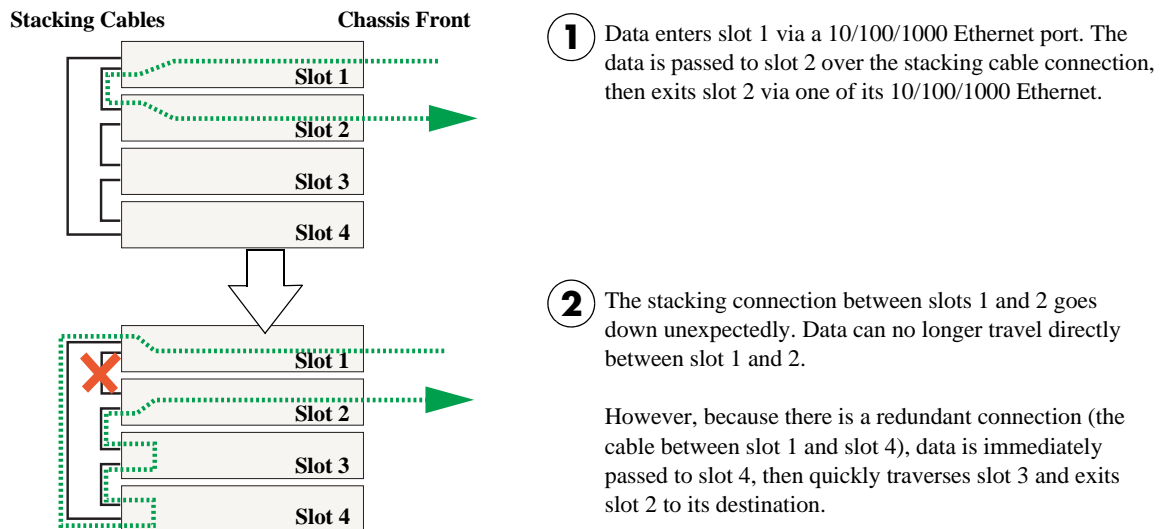

**1** Data enters slot 1 via a 10/100/1000 Ethernet port. The data is passed to slot 2 over the stacking cable connection, then exits slot 2 via one of its 10/100/1000 Ethernet.

**2** The stacking connection between slots 1 and 2 goes down unexpectedly. Data can no longer travel directly between slot 1 and 2.

However, because there is a redundant connection (the cable between slot 1 and slot 4), data is immediately passed to slot 4, then quickly traverses slot 3 and exits slot 2 to its destination.

## Stacking Cable Redundancy: Recovery Following a Stacking Link Failure

Redundant stacking cables provide a form of *dual* redundancy. As shown in the figure above, the redundant cable allows traffic to flow in the event of a stacking link failure. The redundant cable also provides failover if a *switch* goes down within the stack. Traffic continues to flow between the modules that remain operational, as shown in the diagram below:

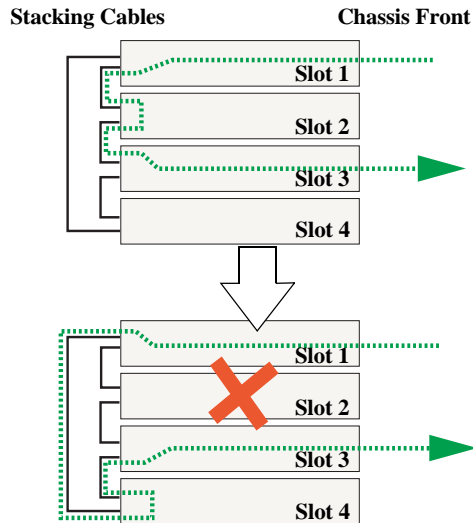

**1** Data enters slot 1 through a 10/100/1000 Ethernet port. The data traverses slot 2 via the stacking cables and exits slot 3 through one of its 10/100/1000 Ethernet.

**2** The slot 2 switch goes down unexpectedly. Data can no longer move through slot 2.

However, because there is a redundant connection (the cable between slot 1 and slot 4), data immediately traverses slot 4 and then exits slot 3 to its destination.

### Stacking Cable Redundancy: Recovery Following a Switch Failure within the Stack

## Checking Redundant Stacking Cable Status

To check whether a redundant stacking cable connection exists between the top-most and bottom-most switches in the stack, use the `show stack status` command. For example:

```
-> show stack status
Redundant cable status : present
Tokens used           : 12
Tokens available      : 20
```

In this example, a redundant stacking cable connection is present between the top-most and bottom-most switches in the stack.

# Slot Numbering

For a stack of OmniSwitch 6400 Series switches to operate as a virtual chassis, each module in the stack must be assigned a unique slot number. To view the current slot assignments for a stack, use the **show ni** or **show module** commands. The slot number is also displayed on the front panel of each switch by the LED located on the left side of the chassis (refer to “[LED Status Indicators](#)” on page 2-20 for more information).

There are two ways stacking modules are assigned slot numbers:

- Dynamic slot number assignment by the system software
- Manual slot number assignment by the user



## Dynamic Slot Number Assignment

Dynamic slot number assignment occurs when there are no **boot.slot.cfg** files present in the switches' /flash directories. This is the case for new, "out of the box," switches that have not been previously booted.

When a brand new stack (or stack with no **boot.slot.cfg** files) is booted, the system software automatically detects the module with the lowest MAC address. This module is assigned the primary management role (see [page 5-3](#)) and, by default, is given the slot number 1. The module connected to the primary's stacking port A is automatically assigned the secondary management role and given the slot number 2.

As the other modules in the stack become operational, they are assigned idle roles and are automatically assigned unique slot numbers (3–8, depending on the number of switches in the stack). The slot numbering for idle modules is determined by each module's physical location in the stack. Refer to the diagrams below for more information on dynamic slot numbering.

---

**Note.** As the slot numbers are dynamically assigned, **boot.slot.cfg** files are auto-generated in the /flash directory of each switch. When modules are subsequently booted, each switch reads its slot number assignment from this file and comes up accordingly.

---

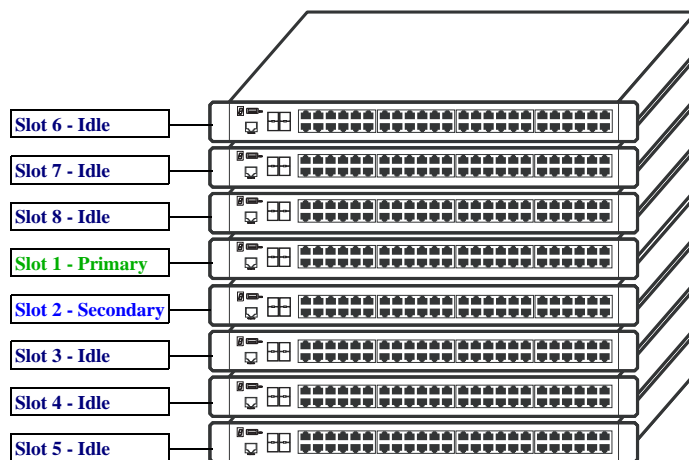

In this example, the fourth switch from the top is elected the primary management module for the stack. (It can be assumed that this switch has the lowest MAC address in the stack.) This switch is automatically assigned slot number 1.

The switch immediately below is connected to the primary switch's stacking port A and, as a result, is assigned the secondary management role and given slot number 2.

The system software allows the switch immediately below slot 2 to have the next slot number preference. It is assigned an idle role and given the slot number 3. The switch immediately below slot 3 is given the slot number 4, and so on. When the bottom of the stack is reached, the slot numbering sequence resumes at the top of the stack, as shown. This helps ensure a more ordered and manageable stack topology.

### Dynamic Slot Numbering Example 1

If the switch with the lowest MAC address happens to be the bottom-most module in the stack, slot numbering will not resume from the top of the stack. Instead, the system software will select the secondary module using the standard method (i.e., the switch connected to the primary's stacking port A), then continue to number the stack from the bottom up. This intuitive slot assignment provides the cleanest and most manageable stack topology. Refer to the diagram below for more information:

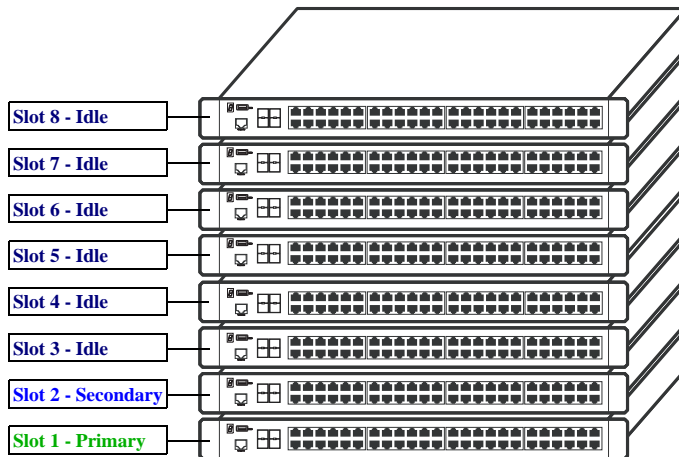

In this example, the bottom switch is elected the primary management module for the stack. (It can be assumed that this switch has the lowest MAC address in the stack.) This switch is automatically assigned slot number 1.

The switch immediately above is connected to the primary switch's stacking port A and, as a result, is assigned the secondary management role and given slot number 2.

The system software then sequentially assigns slot numbers up the stack. In other words, the switch immediately above slot 2 is assigned the slot number 3; the switch immediately above slot 3 is assigned the slot number 4, and so on. This default procedure ensures the most ordered and manageable stack topology out of the box.

### Dynamic Slot Numbering Example 2

## Manual Slot Number Assignment

To manually assign slot numbers to one or more modules in a stack, use the **stack set slot** command. This command writes slot information to the **boot.slot.cfg** file located in a switch's /flash directory. It is this *saved slot* information that the switch will assume following a reboot.

Manually assigning slot numbers can be useful in reordering existing slot numbers in order to create a sequential numbering scheme from the top of the stack to the bottom (or vice-versa). Refer to the following example:

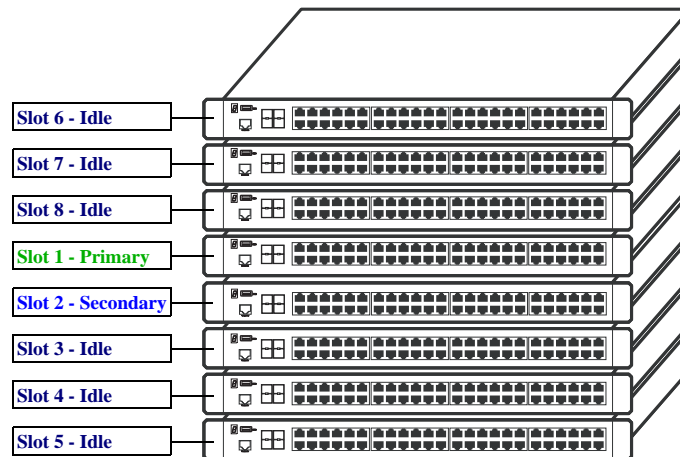

This example, taken from [page 5-19](#), shows a stack in which the primary and secondary switches are physically positioned in the middle of the stack. Although the stack will operate normally with this primary and secondary module positioning, it may be preferable for management purposes to have the primary and secondary switches at either the top or the bottom of the stack. For this example, the primary and secondary roles will be assigned to the top of the stack. This is accomplished by entering the following commands:

```
-> stack set slot 6 saved-slot 1
-> stack set slot 7 saved-slot 2
-> stack set slot 8 saved-slot 3
-> stack set slot 1 saved-slot 4
-> stack set slot 2 saved-slot 5
-> stack set slot 3 saved-slot 6
-> stack set slot 4 saved-slot 7
-> stack set slot 5 saved-slot 8
-> reload all
```

Because slot 6 is the top-most switch in the stack, it is reassigned the slot 1 (i.e., primary) position; because slot 7 is located immediately below slot 6, it is reassigned the slot 2 (i.e., secondary) position, etc.

Note that the modules were not reloaded one-by-one, even though the **stack set slot** command provides optional syntax for doing so. Instead, new slot number information is first saved to each **boot.slot.cfg** file across the stack. The reboot is saved for last in order to avoid duplicate slot numbers within the stack, which would cause unwanted pass-through mode conditions (see [page 5-12](#)).

When the stack comes up following the reboot, the manually-configured slot numbers display as follows:

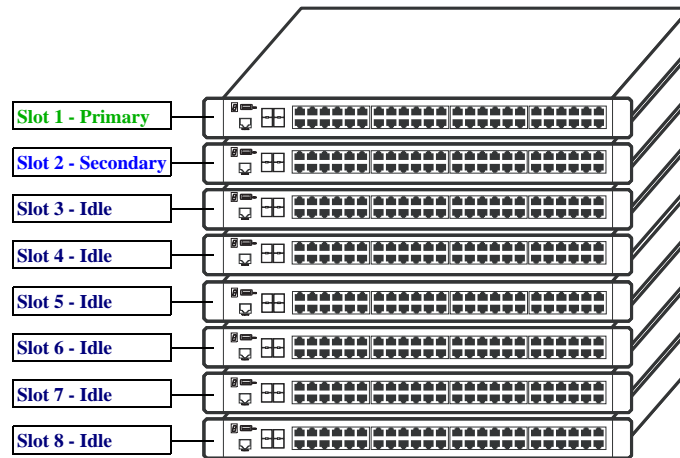

---

**Note:** The `stack set slot` command can also be used to manually correct duplicate saved slot assignments within the stack topology. Refer to pages 5-12 through 5-14 for detailed information.

---

## Reverting to the Dynamic Slot Numbering Model

To clear the `boot.slot.cfg` files from the stack's `/flash` directories, use the `stack clear slot` command on all modules and then reboot the stack. For example:

```
-> stack clear slot 1
-> stack clear slot 2
-> stack clear slot 3
-> stack clear slot 4
-> stack clear slot 5
-> stack clear slot 6
-> stack clear slot 7
-> stack clear slot 8
-> reload all
```

The commands shown above clear the saved slot information from all modules in an eight-module stacked configuration and then reboot the stack. Because the system software no longer has preassigned slot information to read during the boot process, the stack uses the dynamic slot number assignment method described on [page 5-19](#).

# Hot-Swapping Modules In a Stack

As with chassis-based switches, such as the OmniSwitch 9700/9800, NI modules within an OmniSwitch 6400 Series virtual chassis are hot-swappable. NI modules are essentially those modules operating in the stack in idle mode. These modules can be removed from, or added to, an existing stack without disrupting other modules in the stack.

## Removing Switches from an Existing Stack

When removing switches from an existing stack, observe the following important guidelines:

- Do not attempt to hot-swap modules operating in primary or secondary management roles
- Be sure the stacking cables and stacking cable redundancy are not disrupted

Hot-swapping is intended for switches in *idle* and, if applicable, *pass-through* status only. Removing primary or secondary management modules from a stack will trigger a failover sequence, i.e., one or more additional modules within the stack must reload in order to reassign the management roles. Whenever possible, avoid removing a switch that is operating as a primary or secondary management module.

Also, removing a switch from a stacked configuration can disrupt stack cabling at the rear of the stack. When removing a module, be sure that stacking link integrity, including important stacking cable redundancy, is maintained between all remaining modules. For more information on stacking cable connections, refer to [page 5-16](#).

## Inserting Switches Into an Existing Stack

When inserting switches into an existing stack, observe the following important guidelines:

- Avoid duplicate saved slot numbers
- Never attempt to operate more than eight switches in a single stack
- Make sure all switches are running the same software version.

---

**Note.** Other stackable Alcatel-Lucent products, such as the OmniSwitch 6850 switch, *cannot* be added to an OmniSwitch 6400 Series virtual chassis.

---

To avoid duplicate slot numbers, simply make sure that any modules being added to an existing stack have been cleared of preassigned slot information. In other words, verify that there is no **boot.slot.cfg** file present in the /flash directory of any switch being added. When the switch is connected to the existing stack and booted, the system software automatically assigns it a unique slot number. No duplicate slot errors occur.

---

**Note.** If it is preferable to add a switch with an existing **boot.slot.cfg** file to a stack, be sure that the saved slot number of the incoming switch is not already assigned to a switch operating in the stack.

---

## Merging Stacks

Merging stacks involves connecting two or more operational stacks and attempting to reboot them as a single virtual chassis. In most cases, errors will result. To merge stacks without causing errors, select one stack that is to remain up and running and then add modules from the other stack(s) by following the steps below:

- 1** Make sure all switches are running the same software version.
- 2** Clear the saved slot information from all incoming modules. This will ensure that they are each assigned unique slot numbers when they join the stack.
- 3** After clearing the saved slot information, power off all incoming modules.
- 4** Connect the stacking cables for all incoming modules to the existing, operational stack as required. Be sure to provide stacking cable redundancy. For information on stack cabling, refer to [page 5-16](#).
- 5** Power on all incoming modules.

---

**Note.** No more than eight switches can operate in a single stacked configuration at any time.

---

# Reloading Switches

Reloading is essentially a soft boot of a switch. Users can reload stacked modules operating in any role—i.e., primary, secondary, idle, and pass-through. Refer to the sections below for more information.

## Reloading the Primary Management Module

If the switch with the primary management role is reloaded, the switch with the secondary role automatically takes over primary management functions. In other words, the switch with the secondary role assumes the primary role as soon as the reload is initiated.

Meanwhile, the idle switch with the next lowest slot number automatically assumes the secondary role. When the reloaded switch (the former primary module) comes back up, it assumes an idle role within the stack.

To reload the primary management module, use the **reload** command. The optional syntax **primary** can be used in the command line, but is not required. For example:

```
-> reload primary
```

---

**Note.** A primary management module reload can also be scheduled for a later time or date. For information on scheduling a primary module reload, as well as additional command details, refer to the *OmniSwitch CLI Reference Guide*.

---

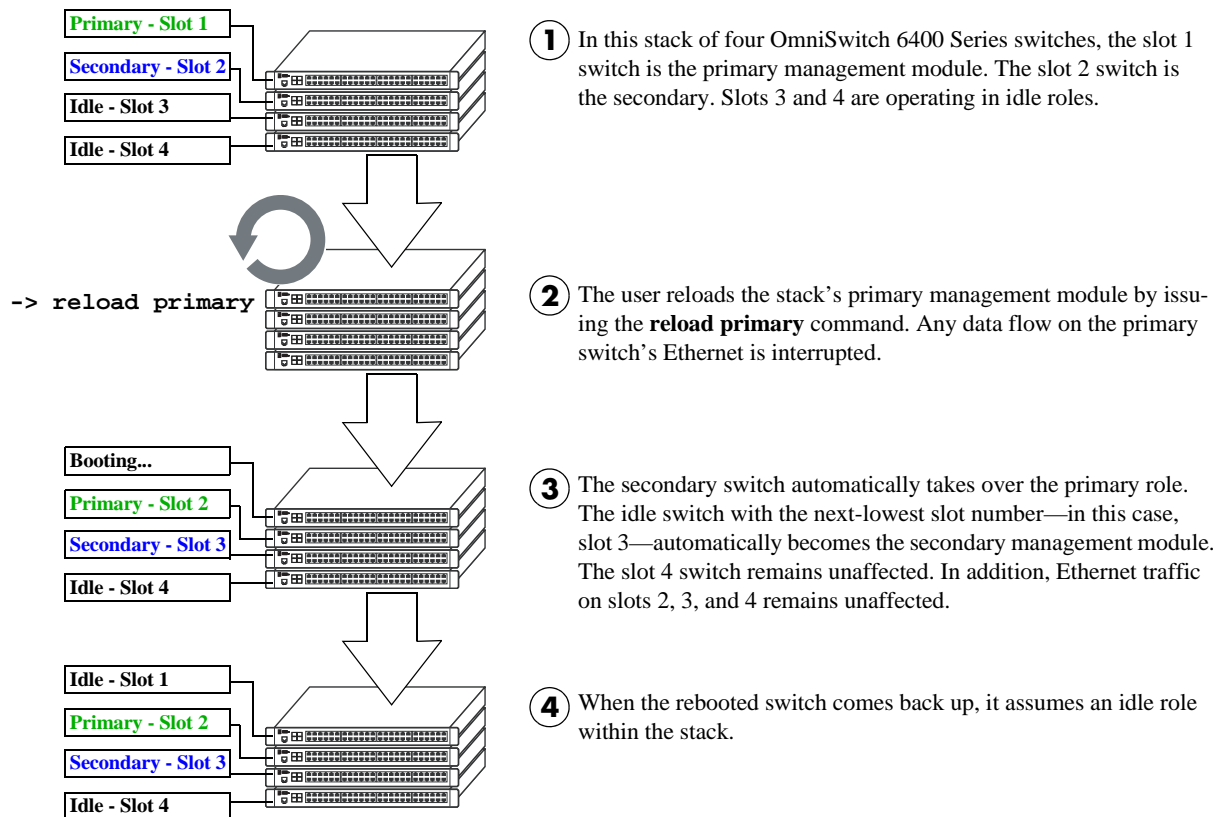

### Reloading the Primary Management Module In a Stack of Three or More

If there are only two switches in the stack, the switch that was reloaded (the former primary) assumes the secondary role when it comes back up.

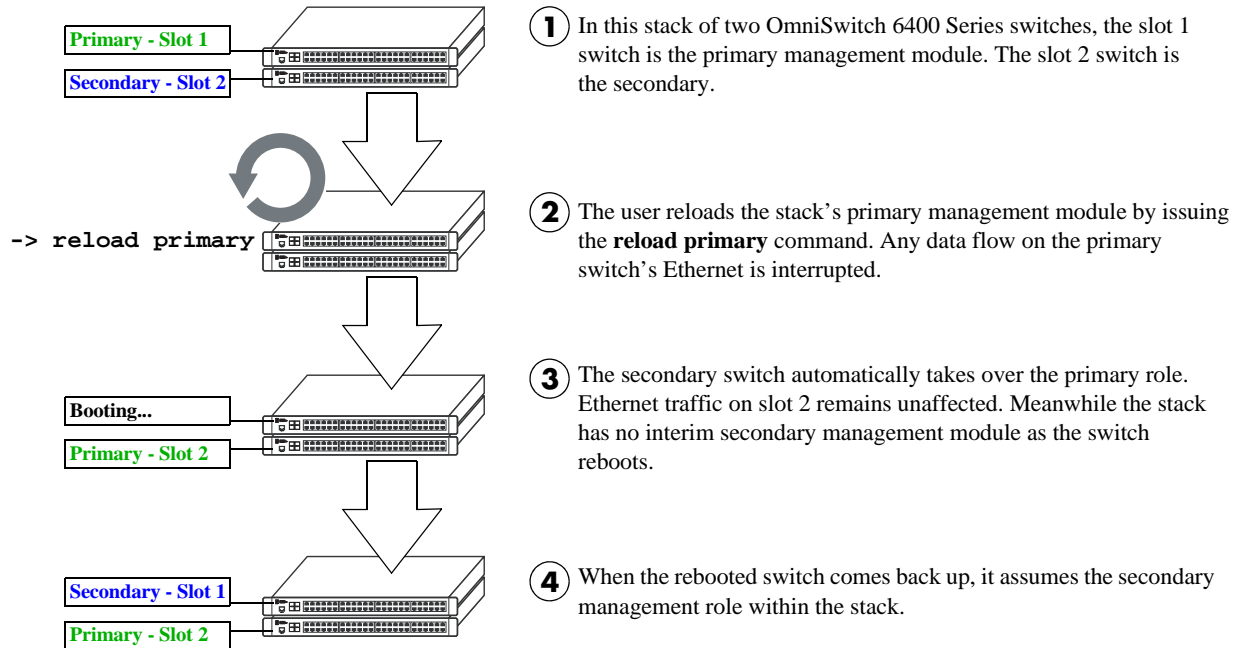

### Reloading the Primary Management Module In a Stack of Two



## Reloading the Secondary Management Module

If the switch with secondary management role is reloaded, the idle switch with the lowest slot number will automatically assume the secondary role. The reloaded switch (the former secondary) will assume an idle role when it comes back up.

Meanwhile, the switch with the primary management role, as well as any other idle modules in the stack, continue operations without interruption.

To reload the secondary management module, use the **reload** command. Be sure to include the syntax **secondary** in the command line. For example:

```
-> reload secondary
```

---

**Note.** A secondary management module reload can also be scheduled for a later time or date. For information on scheduling a secondary module reload, as well as additional command details, refer to the *OmniSwitch CLI Reference Guide*.

---

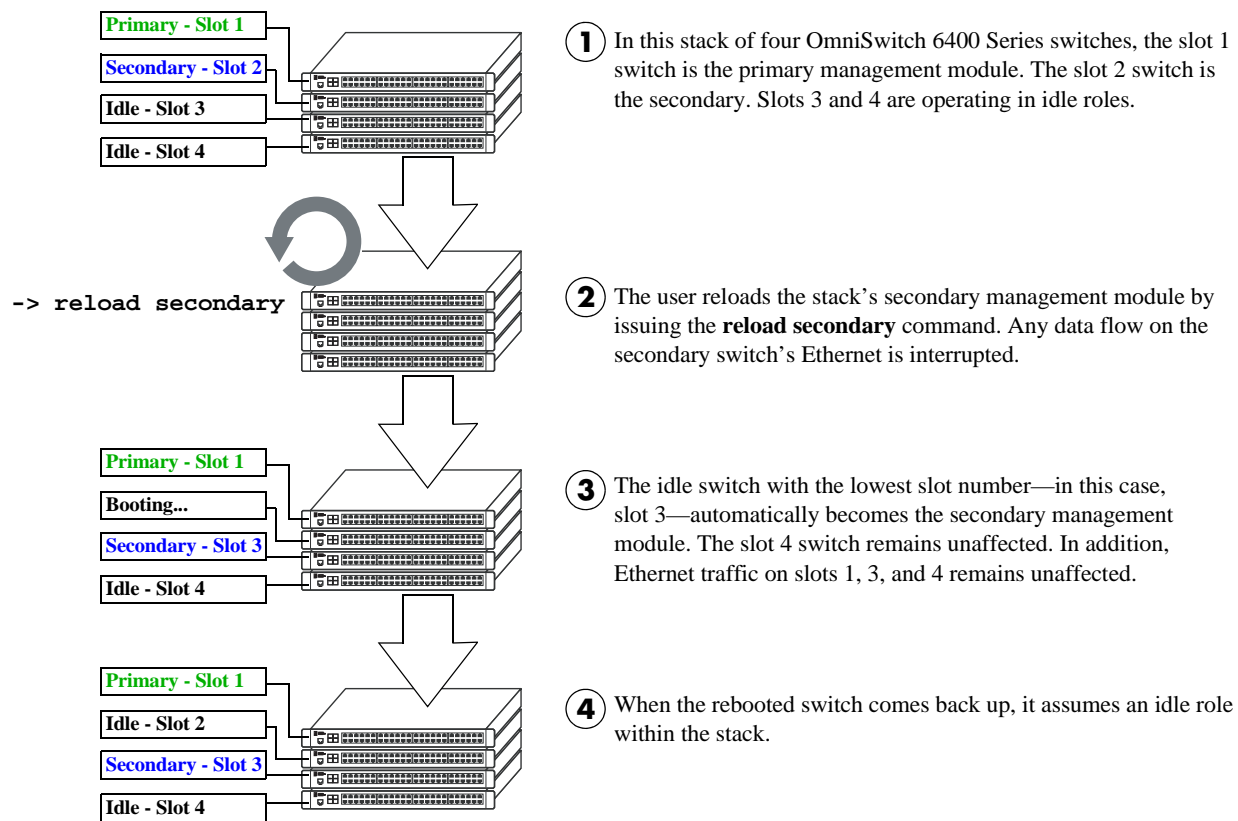

### Reloading the Secondary Management Module In a Stack of Three or More

If there are only two switches in the stack, the switch that was reloaded (the former secondary) resumes the secondary role when it comes back up.

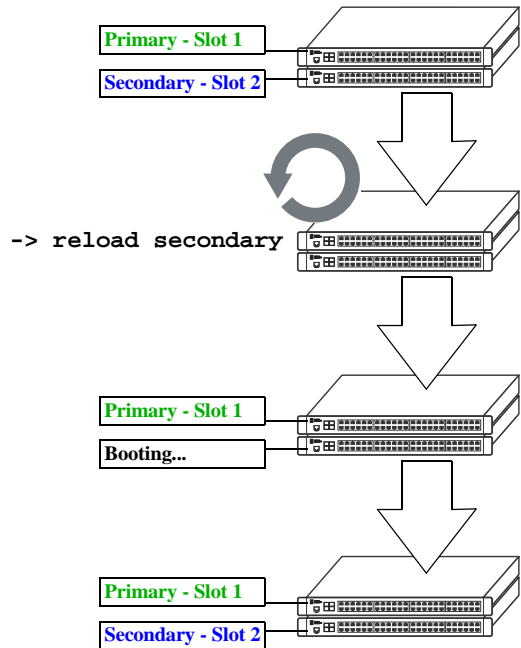

- ① In this stack of two OmniSwitch 6400 Series switches, the slot 1 switch is the primary management module. The slot 2 switch is the secondary.
- ② The user reloads the stack's secondary management module by issuing the **reload secondary** command. Any data flow on the secondary switch's Ethernet is interrupted.
- ③ As the secondary switch reboots, the primary management module continues to operate without interruption. Meanwhile the stack has no interim secondary management module as the switch reboots.
- ④ When the rebooted switch comes back up, it assumes the secondary management role within the stack.

### Reloading the Secondary Management Module In a Stack of Two

## Reloading Switches with Idle Roles

Similar to reloading Network Interface (NI) modules on chassis-based switches such as the OmniSwitch 9700/9800, modules operating in idle status within a stack can be reloaded via the CLI.

---

**Note.** Any traffic being passed on the module's Ethernet will be interrupted during the reboot. Other modules within the stack will continue to operate without interruption.

---

To reset a single module operating in idle mode, use the **reload ni** command. Be sure to include the slot number of the idle switch in the command line. For example:

```
-> reload ni 3
```

Only one idle switch can be reloaded at a time. In order to reload multiple idle switches at once, the entire stack must be reloaded using the **reload all** command.

After reloading a switch operating in an idle role, the switch resumes idle status when it comes back up, *despite its saved slot number*. In other words, if an idle switch with a saved slot number of 1 is reloaded, it resumes its previous idle role. Although it has the lowest possible saved slot number, it does not take over the primary management role. In order for this switch to take over the primary role, all switches in the stack must be reloaded.

---

**Note.** For more information on reloading all the switches in a stack, refer to [page 5-30](#). For more information on idle status, refer to [page 5-11](#).

---

## Reloading Switches in Pass-Through Mode

Pass-through mode is a state in which a switch has attempted to join a stack but has been denied primary, secondary, and idle status. Because this is essentially an error state, the pass-through condition must be resolved and any modules operating in pass-through mode must be reloaded.

To reload a module operating in pass-through mode, use the **reload pass-through** command. Be sure to include the slot number of the pass-through switch in the command line. For example:

```
-> reload pass-through 1001
```

---

**Note.** Before issuing the **reload pass-through** command, be sure to resolve any conditions causing the switch to operate in pass-through mode. Otherwise, the switch is likely to come up again in pass-through mode. For detailed information, including steps used to recover from pass-through, refer to [page 5-12](#).

---

## Reloading All Switches in a Stack

Reloading all switches in the stack is essentially a full reboot of the virtual chassis. This can be useful in restoring a stack's previously configured topology—i.e., the stack's saved slot numbers and management roles. Note, however, that all data flow on the stack is interrupted whenever a full reboot is issued.

To reset all switches in a stack use the **reload all** command. For example:

```
-> reload all
```

---

**Important.** Before issuing the **reload all** command, be sure to read the sections below. Understanding topics such as software synchronization and the effects of saved slot information can help users avoid unexpected results following a full stack reboot.

---

### Software Synchronization During a Full Reload

If the checksum value on the stack's non-primary switches differs in any way from the checksum value on the primary switch, the primary switch automatically distributes its system and configuration software to all other switches in the stack whenever a full reload is executed.

During this automatic software synchronization, system and configuration software on the secondary and idle switches is overwritten. Because the primary switch's "last known good" software is propagated to all switches, the synchronization process helps ensure effective redundancy across the stack.

### Effects of Saved Slot Number Information on the Reload Process

Depending on the status of saved slot information across the stack, there are different slot numbering and management role scenarios that can occur following a full reboot. For this reason, checking the current stack topology before issuing a full reboot is strongly recommended. To check the current stack topology, use the **show stack topology** command. Refer to the *OmniSwitch CLI Reference Guide* for detailed command information.

Possible saved slot number conditions include:

- All switches have unique saved slot information
- No switches in the stack have saved slot information
- Some switches have saved slot information, others do not
- Two or more switches have duplicate slot information

#### All Switches Have Unique Saved Slot Information

If a full reload is issued and all switches have unique slot numbers saved to their **boot.slot.cfg** files, the slot numbers will be assigned according to the saved slot information. The primary management role will be given to the switch with the *lowest* saved slot number. The secondary management role will be given to the switch with the *second-lowest* saved slot number. All other switches will be assigned to idle roles.

An illustrated example of this method for assigning slot numbers and management roles is provided on pages [5-21](#) and [5-22](#).

## No Switches In the Stack Have Saved Slot Information

If a full reload is issued and no switches in the stack have unique slot numbers, slot numbers will be assigned beginning with the switch with the lowest MAC address. (This can occur if the **boot.slot.cfg** file has been deleted from each switch's /flash directory—e.g., by issuing the **stack clear slot** command for all modules in the stack.)

The switch with the lowest MAC address is assigned slot number 1 and given the primary management role. The switch connected to stacking port A of the primary switch is automatically assigned slot number 2 and given the secondary management role. Stack cabling is then used to determine the dynamic slot numbering of the remaining modules in the stack. The switch immediately adjacent to slot 2 is assigned slot number 3 and given an idle role, etc.

An illustrated example of this method for assigning slot numbers and management roles is provided on pages [5-19](#) and [5-20](#).

## Some Switches Have Saved Slot Information, Others Do Not

If only *some* switches in the stack have **boot.slot.cfg** files in their /flash directories, the system software will first read the contents of these files and then dynamically assigns unique slot numbers to any switches that do not have saved slot information. The primary management role will be given to the switch with the *lowest* saved slot number. The secondary management role will be given to the switch with the *second-lowest* saved slot number. All other switches will be assigned to idle roles.

When unique slot numbers are dynamically assigned by the system software, a **boot.slot.cfg** file is automatically generated with the new slot information. Because all switches now have unique saved slot information, any subsequent **reload all** commands issued will cause the stack to come up as described in the section, "[All Switches Have Unique Saved Slot Information](#)" on page [5-30](#).

## Two or More Switches Have Duplicate Slot Information

If a full stack reboot is issued and the same slot number is found in the **boot.slot.cfg** file of two or more switches, the switch with the lowest MAC address is allowed to come up and operate normally. Meanwhile, any other switches with the duplicate slot number come up in *pass-through mode*.

The pass-through mode is essentially an error state in which a switch has been denied primary, secondary, and idle roles within the stack. When a switch is in pass-through mode, its Ethernet are brought down and cannot pass traffic. It is for this reason that users should always check the current saved slot number for each switch before issuing the **reload all** command. To check the current saved slot information across the stack, use the **show stack topology** command. For detailed information on pass-through mode, refer to "[Pass-Through Mode](#)" on page [5-12](#).

## Avoiding Split Stacks

The term “splitting” a stack refers to the creation of isolated modules within the virtual chassis. A split stack can result from the following conditions:

- Two or more *non-adjacent* switches are reloaded simultaneously
- The stack is reloaded without a redundant stacking cable connection

The sections below offer simple guidelines for avoiding splitting the stack during the reload process.

### **Do Not Reload Non-Adjacent Switches Simultaneously**

If non-adjacent switches in the stack—for example, the top switch in the stack and the third-from-top switch in the stack—are reloaded *simultaneously*, a problem will occur. The switch between the two non-adjacent switches will become isolated and the virtual chassis will be effectively split.

To avoid splitting the stack, do not reload the two non-adjacent switches simultaneously. Instead, simply reload the top switch first, then reload the third-from-top switch, or vice-versa.

### **Be Sure a Redundant Stacking Cable is Installed at All Times**

Another important guideline for avoiding split stacks involves the redundant stacking cable. In order to avoid isolated modules within the virtual chassis, simply make sure that a redundant stacking cable connection exists between the top-most and bottom-most switches at all times.

For more information on the redundant stacking cable connection, refer to [page 5-16](#).

# Changing the Secondary Module to Primary

OmniSwitch 6400 Series stacks allow users to manually force the secondary switch to assume the primary management role. This is referred to as “takeover.” The behavior of a takeover is similar to that of reloading the primary management module (see [page 5-25](#)).

Whenever a takeover is initiated, the switch with the secondary role automatically takes over primary management functions. The primary switch is automatically reloaded and any traffic being passed on the primary switch’s Ethernet is interrupted.

Meanwhile, the idle switch with the next-lowest slot number automatically assumes the secondary role. When the former primary module comes back up, it assumes an idle role within the stack.

To initiate a takeover sequence, use the **takeover** command. For example:

```
-> takeover
```

---

**Note.** Before using the **takeover** command, verify that the switches in the stack are synchronized. Otherwise, data flow and switch management functions may be interrupted due to incorrect or outdated software when a switch takes over the primary management role. For more information, refer to [“Synchronizing Switches in a Stack”](#) on [page 5-35](#).

---

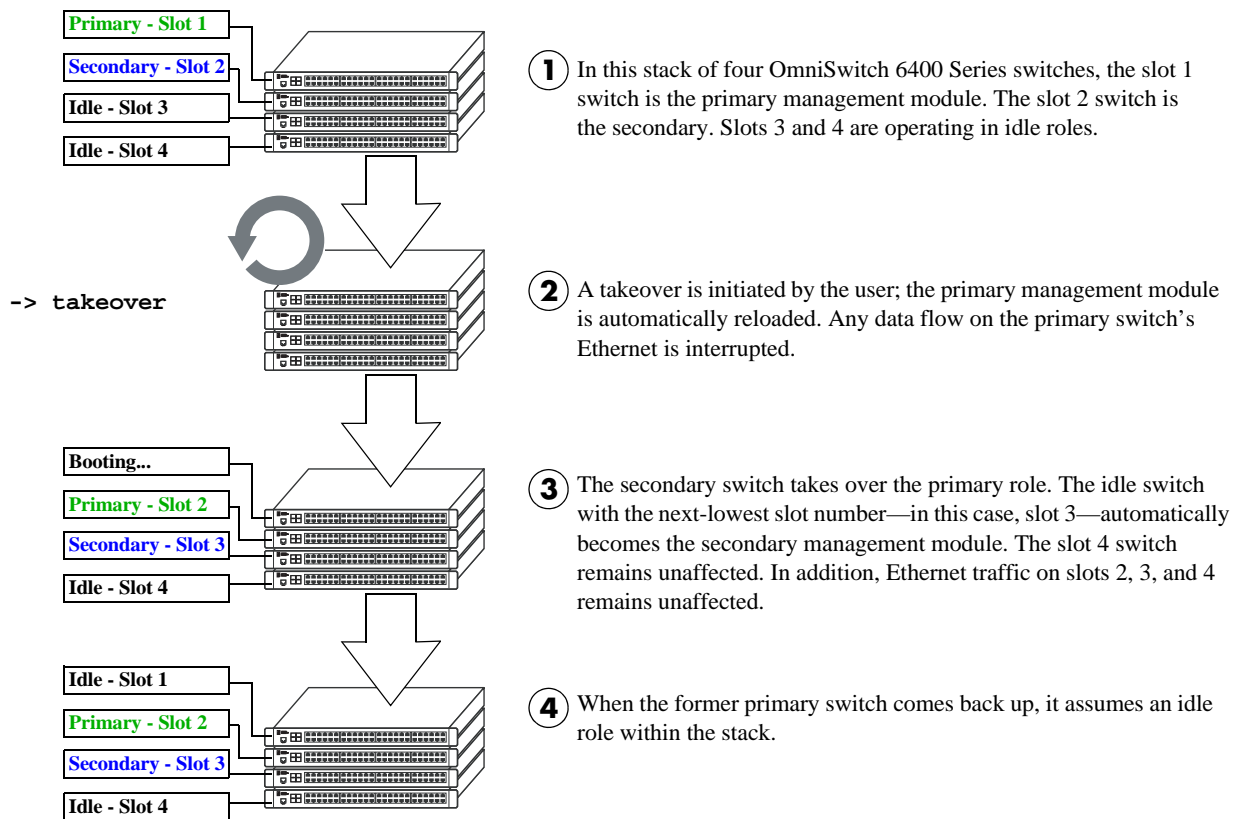

**Takeover Behavior In a Stack of Three or More**

If there are only two switches in the stack, the former primary switch resumes the secondary role when it comes back up following the takeover.

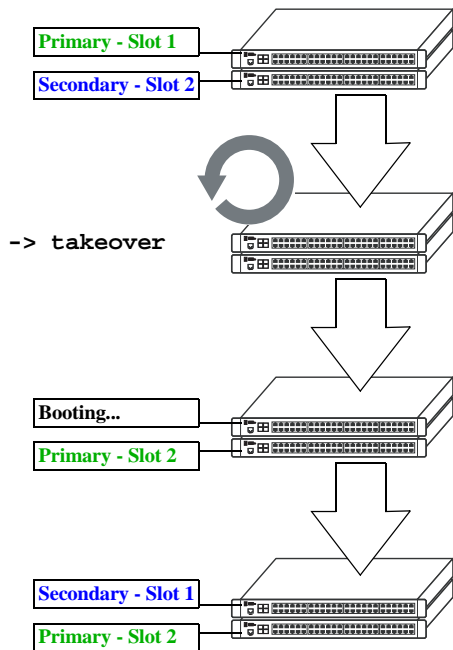

- ① In this stack of two OmniSwitch 6400 Series switches, the slot 1 switch is the primary management module. The slot 2 switch is the secondary.
- ② A takeover is initiated by the user; the primary management module is automatically reloaded. Any data flow on the primary switch's Ethernet is interrupted.
- ③ The secondary switch takes over the primary role. Ethernet traffic on slot 2 remains unaffected. Meanwhile the stack has no interim secondary management module as the switch reboots.
- ④ When the former primary switch comes back up, it assumes the secondary management role within the stack.

**Takeover Behavior In a Stack of Two**



# Synchronizing Switches in a Stack

Management module synchronization refers to the process of copying all files in the /flash/working and /flash/certified directories of the primary management module to the /flash/working and /flash/certified directories of all the other switches in the stack. The system and configuration software on the non-primary switches—i.e., the secondary management module and any modules operating in idle—is overwritten.

The synchronization process ensures that the contents of these directories match exactly for all switches across the stack. This can be especially useful after new software has been loaded to the primary management module. Further, synchronization prevents any switch from assuming a management role within the stack with incorrect or outdated software or configuration files. Because the primary switch's "last known good" software is propagated to all switches, the synchronization process helps ensure effective redundancy across the stack.

In order to maintain effective management module redundancy, switches in the stack must be synchronized at all times. To determine whether a stack is in need of synchronization, use the [show running-directory](#) command. For example:

```
-> show running-configuration

CONFIGURATION STATUS
  Running CMM           : PRIMARY,
  CMM Mode              : DUAL CMMs,
  Current CMM Slot     : 1,
  Running configuration : WORKING,
  Certify/Restore Status : CERTIFY NEEDED
SYNCHRONIZATION STATUS
  Flash Between CMMs   : NOT SYNCHRONIZED,
  Running Configuration : NOT AVAILABLE,
  Stacks Reload on Takeover: PRIMARY ONLY
```

This example shows a switch on which the /flash directories between the management modules are not synchronized. To manually synchronize all switches in the stack, enter the following command:

```
-> copy working certified flash-syncro
```

When the synchronization process is initiated, modules within the stack continue to operate without interruption and data flow across the stack is unaffected.

## Automatic Synchronization During a Full Reload

If the checksum value on the stack's non-primary switches differs in any way from the checksum value on the primary switch, the primary switch automatically distributes its system and configuration software to all other switches in the stack whenever a full reload is executed.

For more information on initiating a full reload, see [“Reloading All Switches in a Stack” on page 5-30](#).

---

**Note.** For more information on management module synchronization and managing the /flash/working and /flash/certified directories, refer to the “Managing CMM Directory Content” chapter in the *Switch Management Guide*.

---

## Monitoring the Stack

As shown in the previous sections, monitoring the current status and operation of all elements in a stack can help users avoid unexpected stack conditions. The table below includes CLI commands that are useful in monitoring stack conditions.

CLI Commands Used for Monitoring a Stack	
<b>show stack topology</b>	Displays the current operating topology of switches within a stack.
<b>show stack status</b>	Displays the current redundant stacking cable status and token availability for a stacked configuration.
<b>show running-directory</b>	Displays the directory from where the switch was booted. This command also shows important information, including whether the software across the stack is synchronized.
<b>show chassis</b>	Displays basic configuration and status information for the switch chassis.
<b>show cmm</b>	Displays basic hardware and status information for primary and secondary management modules operating in the stack.
<b>show ni</b>	Displays basic hardware and status information for modules currently operating in the stack.
<b>show module</b>	Displays basic information for modules installed in the stack. Modules include primary and secondary management modules and any modules operating in idle status.
<b>show module long</b>	Displays detailed information for modules installed in the stack. Modules include primary and secondary management modules and any modules operating in idle status.
<b>show module status</b>	Displays basic status information for modules installed in the stack. Modules include primary and secondary management modules and any modules operating in idle status.
<b>show power</b>	Displays hardware information and current status for chassis power supplies. This includes the status of backup power supplies, if applicable.
<b>show fan</b>	Displays the current operating status of each of the six fans operating in each chassis.
<b>show temperature</b>	Displays the current operating chassis ambient temperature, as well as current temperature threshold settings for each of the modules in the stack.

## Visually Monitoring the Stack

Users can also monitor many stack operations by viewing the front panel LEDs on all elements in the stack. Refer to [“LED Status Indicators” on page 2-20](#) for detailed information on LEDs and stack status.

## CLI Commands Supported on Both Primary and Secondary Management Modules

Although most CLI commands are executed when logged into the switch with the primary management role, there is a group of commands that is supported when logged in to either the primary or secondary management module. For a list of these commands, refer to the tables below.

**Note.** For detailed information on these commands, including command syntax options and definitions, refer to the *OmniSwitch CLI Reference Guide*.

---

### CMM Commands

reload takeover install	debug chassis auto-reboot show running-directory show reload	show microcode
-------------------------------	--	----------------

---

### Chassis Management and Monitoring Commands

show system show hardware info show chassis	show module show module long show module status	show cmm show ni
---	---	---------------------

---

### File Management Commands

cd pwd mkdir rmdir ls dir rename rm	delete cp mv move chmod attrib fsck newfs	ed vi view tty show tty rz more install
--	--	--

---

### Switch Logging and Monitoring Commands

swlog swlog appid level swlog output show log swlog show swlog	debug ktrace debug ktrace appid level debug ktrace show debug systrace debug systrace appid level	debug systrace show debug systrace show log debug memory monitor debug memory monitor show log
--	---	---

---

### Memory Monitoring Commands

show log pmd
--------------



# 6 Booting OmniSwitch 6400 Series Switches

For information on booting stand-alone switches and switches in stacked configurations, refer to the sections below.

## Booting a Stand-Alone Switch

The OmniSwitch 6400 Series switch does not use an on/off switch. The power cord is the switch's only connect/disconnect device. The power connector socket is located on the switch's rear panel. For more information, refer to "[OmniSwitch 6400 Series Chassis and Hardware Components](#)" on page 2-1.

To boot the switch, plug the power cord (provided) into the power connector socket at the switch's rear panel. Next, plug the power cord into an easily-accessible power source, such as a grounded AC outlet or an Uninterruptible Power Supply (UPS).

The switch immediately begins the boot process. Allow a few moments for the switch to boot completely, then verify the status of all LEDs on the switch's front panel. A successful boot for a stand-alone switch displays the following LED states:

LED States for a Stand-Alone Switch	
OK	Solid green
PRI	Solid green
PWR	Solid green
BPS	Solid green: Operational Solid amber: Failed Off: Not present
Slot Indicator	1–8: depending on the slot number value in the <b>boot.slot.cfg</b> file. The default value is 1.

If any of the LED state differs from the states shown in the table above, refer to [page 2-20](#) for more information. Contact Alcatel-Lucent Customer Support if the LED state persists.

For information on logging in and configuring your OmniSwitch 6400 Series switch, refer to the *OmniSwitch 6400 Series Getting Started Guide* and *OmniSwitch AOS Release 6 Switch Management Guide*.

## Booting Stacked Configurations

Once the switches have been connected to a virtual chassis, the next step is to manually power on the stack. The OmniSwitch 6400 Series switch does not use an on/off switch. The power cord is the switch's only connect/disconnect device. The power connector socket is located on the switch's rear panel. For more information, refer to [“OmniSwitch 6400 Series Chassis and Hardware Components” on page 2-1](#).

To boot the stack, plug the power cord (provided) into the power connector socket at the rear panel of each switch in the stack. Next, plug all power cords, in rapid succession, into easily-accessible power sources, such as grounded AC outlets or an Uninterruptible Power Supply (UPS).

---

**Note.** Be sure to power on all switches in the stack in *rapid succession*; otherwise, switches may be assigned unintended stack management roles. Refer to [Chapter 5, “Managing OmniSwitch 6400 Series Stacks.”](#) for detailed information.

---

The stack immediately begins the boot process. Allow a few moments for all elements in the stack to boot completely, then verify the status of all LEDs on the switch's front panel. A successful boot for a stacked OmniSwitch displays the following LED states.

---

### LED States for a Stacked Configuration

---

OK	Solid green for all switches.
PRI	Solid green: Primary management module Solid amber: Secondary management module Off: Idle (Neither primary or secondary)
	Detailed information for primary, secondary, and idle roles is provided in <a href="#">Chapter 5, “Managing OmniSwitch 6400 Series Stacks.”</a>
PWR	Solid green for all switches.
BPS	Solid green: Operational Solid amber: Failed Off: Not present
Slot Indicator	1–8: Depending on the slot number assignment for each switch. See <a href="#">Chapter 5, “Managing OmniSwitch 6400 Series Stacks.”</a> for detailed information.

---

If any of the LED state differs from the states shown in the table above, refer to [page 2-20](#) for more information. Contact Alcatel-Lucent Customer Support if the LED state persists.

# Monitoring the Chassis

OmniSwitch 6400 Series switches can be monitored and managed via the console port using Command Line Interface (CLI) commands. The switches can also be monitored and managed remotely using CLI commands, WebView, SNMP, and OmniVista.

The section below provides some examples of useful hardware-related monitoring CLI commands. Refer to the *OmniSwitch CLI Reference Guide* for detailed information on all management and monitoring commands used with the OmniSwitch 6400 Series switch.

## Checking the Overall Chassis Status

To check the overall status of a chassis, including the chassis type, and current administrative and operational status, use the `show chassis` command. For example:

```
-> show chassis
```

```
Chassis 1
  Model Name:          OS6400-48,
  Description:        10/100/1000,
  Part Number:        902274-10,
  Hardware Revision:  005,
  Serial Number:      439L0024,
  Manufacture Date:   FEP 22 2008,
  Admin Status:       POWER ON,
  Operational Status: UP,
  Number Of Resets:   1
```

For a complete list of output definitions for this command, refer to the *OmniSwitch CLI Reference Guide*.

## Checking the Temperature Status

To check chassis temperature status, including the current temperature and configured threshold values, use the `show temperature` command. For example:

```
-> show temperature
```

```
Temperature for chassis 1
  Hardware Board Temperature (deg C)      = 38,
  Hardware Cpu Temperature (deg C)        = N/A,
  Temperature Upper Threshold Range (deg C) = 30 to 72,
  Temperature Upper Threshold (deg C)     = 57,
  Temperature Range                       = UNDER THRESHOLD,
  Temperature Danger Threshold (deg C)    = 72
```

For a complete list of output definitions for this command, refer to the *OmniSwitch CLI Reference Guide*.

## Checking the Fan Status

To check the current status for all six fans in the chassis, use the **show fan** command. For example:

```
-> show fan
Chassis Fan  Status
-----+-----
      1      1  Running
      1      2  Running
```

For a complete list of output definitions for this command, refer to the *OmniSwitch CLI Reference Guide*.

## Checking the Power Supply Status

For information on checking power supplies for OmniSwitch 6400 Series switches, refer to **show power**.

## Additional Monitoring Commands

---

### CLI Commands Used for Monitoring a Chassis

---

<b>show cmm</b>	Displays the basic hardware and status information for primary and secondary management modules (if applicable).
<b>show ni</b>	Displays the basic hardware and status information for individual modules. If the switch is a standalone, information for the stand alone switch displays.
<b>show module</b>	Displays the basic information for individual modules. If the switch is a standalone, information for the stand-alone switch displays.
<b>show module long</b>	Displays the detailed information for individual modules. If the switch is a standalone, information for the standalone switch displays.
<b>show module status</b>	Displays the basic status information for individual modules. If the switch is a standalone, information for the standalone switch displays.

---

## Using LEDs to Visually Monitor the Chassis

The front panel of OmniSwitch 6400 Series switches provides status LEDs that are useful in visually monitoring the status of standalone switches, as well as switches stacked into a virtual chassis.

For detailed information on all OmniSwitch 6400 Series LEDs, refer to [page 2-20](#).



# A Regulatory Compliance and Safety Information

This appendix provides information on regulatory agency compliance and safety for OmniSwitch 6400 switches.

## Declaration of Conformity: CE Mark

This equipment is in compliance with the essential requirements and other provisions of Directive 2004/108/EC (EMC), 2006/95/EC (LVD), 91/263/EEC (Telecom Terminal Equipment, if applicable), 1999/5/EC (R&TTE, if applicable).

**Français:** Cet équipement est conforme aux exigences essentielles et aux autres provisions de la Directive 2004/108/EC (EMC), 2006/95/CE (LVD), 91/263/CEE (équipements terminaux de télécommunications, le cas échéant), 1999/5/EC (R&TTE, le cas échéant).

**Deutsch:** Diese Ausrüstung erfüllt die wesentlichen Anforderungen und sonstigen Bestimmungen der Richtlinien 2004/108/EG (EMV-Richtlinie), 2006/95/EG (Niederspannungsrichtlinie), 91/263/EWG (Telekommunikationsendeinrichtungen, falls zutreffend), 1999/5/EG (Funkanlagen und Telekommunikationsendeinrichtungen, falls zutreffend).

**Español:** Este equipo cumple los requisitos esenciales y otras disposiciones de las directivas 2004/108/CE (EMC), 2006/95/CE (LVD), 91/263/CEE (equipos terminales de telecomunicación, si procede), 1999/5/CE (R&TTE, si procede).

## Waste Electrical and Electronic Equipment (WEEE) Statement

The product at end of life is subject to separate collection and treatment in the EU Member States, Norway and Switzerland and therefore marked with the following symbol:

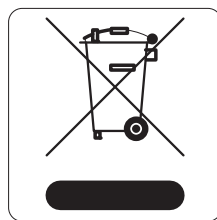

Treatment applied at end of life of the product in these countries shall comply with the applicable national laws implementing directive 2002/96/EC on waste electrical and electronic equipment (WEEE).

# China RoHS: Hazardous Substance Table

## 产品说明书附件

### SUPPLEMENT TO PRODUCT INSTRUCTIONS

**这个文件涉及的是在中华人民共和国境内进口或销售的电子信息产品  
Include this document with all Electronic Information Products imported  
or sold in the People's Republic of China**

部件名称 (Parts)	有毒有害物质或元素 (Hazardous Substance)					
	铅 (Pb)	汞 (Hg)	镉 (Cd)	六价铬 (Cr <sup>6+</sup> )	多溴联苯 (PBB)	多溴二苯醚 (PBDE)
电路模块 (Circuit Modules)	×	○	○	○	○	○
电缆及电缆组件 (Cables & Cable Assemblies)	×	○	○	○	○	○
金属部件 (Metal Parts)	×	○	○	○	○	○
塑料和聚合物部件 (Plastic and Polymeric parts)	○	○	○	○	○	○
对于交付时集成了电池的电子信息产品 For electronic information products delivered with integrated functional batteries:						
电池 (Batteries)	○	○	○	○	○	○
<p>○ : 表示该有毒有害物质在该部件所有均质材料中的含量均在 SJ/ T11363- 2006 标准规定的限量要求以下。 Indicates that the concentration of the hazardous substance in all homogeneous materials in the parts is below the relevant threshold of the SJ/T11363-2006 standard.</p> <p>× : 表示该有毒有害物质至少在该部件的某一均质材料中的含量超出SJ/ T11363- 2006标准规定的限量要求。 Indicates that the concentration of the hazardous substance of at least one of all homogeneous materials in the parts is above the relevant threshold of the SJ/T11363-2006 standard.</p> <p>对销售之日的所售产品, 本表显示, 阿尔卡特朗讯公司供应链的电子信息产品可能包含这些物质。注意: 在所售产品中可能会也可能不会含有所有所列的部件。 <b>This table shows where these substances may be found in the supply chain of Alcatel-Lucent electronic information products, as of the date of sale of the enclosed product. Note that some of the component types listed above may or may not be a part of the enclosed product.</b></p>						

除非另外特别的标注, 此标志为针对所涉及产品的环保使用期标志。某些零部件会有一个不同的环保使用期(例如, 电池单元模块)贴在其产品上。  
此环保使用期限只适用于产品是在产品手册中所规定的条件下工作。  
The Environment- Friendly Use Period (EFUP) for all enclosed products and their parts are per the symbol shown here, unless otherwise marked. Certain parts may have a different EFUP (for example, battery modules) and so are marked to reflect such. The Environment-Friendly Use Period is valid only when the product is operated under the conditions defined in the product manual.



Products are packaged using one or more of the following packaging materials:

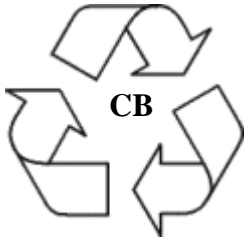

**Corrugated Cardboard**

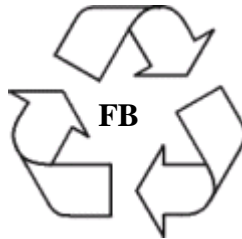

**Corrugated Fiberboard**



**LDPE**

**Low-Density Polyethylene**

# Standards Compliance

The product bears the CE mark. In addition it is in compliance with the following other safety and EMC standards:

All hardware switching modules used in an OmniSwitch 6400 switch comply with Class A standards. Modules with copper connectors meet Class A requirements using unshielded (UTP) cables.

## Safety Standards

- UL 60950-1, 2nd Edition
- CAN/CSA-C22.2 No. 60950-1-07, 2nd Edition
- EN 60950-1 with Amendment II
- IEC 60950-1 2nd Edition
- AS/NZS TS-001 and 60950: Australia
- UL-AR, Argentina
- TUV,UL-GS Mark, Germany
- NOM-019 SCFI, Mexico
- EN 60825-1 Laser
- EN 60825-2 Laser
- CDRH Laser
- CB Certification per IEC 60950-1, Second Edition

## EMC Standards

- FCC Part 15 (CFR 47) Class A
- ICES-003 Class A
- EN 55022: Class A
- CISPR 22 Class A
- AS/NZS 3548 Class A
- VCCI Class A; A1 and A2
- EN 55024: (Immunity)
- EN 61000-3-2
- EN 61000-3-3
- EN 61000-4-2
- EN 61000-4-3
- EN 61000-4-4
- EN 61000-4-5
- EN 61000-4-6
- EN 61000-4-8
- EN 61000-4-11

## Environmental Standards

- ETS 300 019 Storage Class 1.1
- ETS 300 019 Transportation Class 2.3
- ETS 300 019 Stationary Use Class 3.1

## FCC Class A, Part 15

This equipment has been tested and found to comply with the limits for Class A digital device pursuant to Part 15 of the FCC Rules. These limits are designed to provide reasonable protection against harmful interference when the equipment is operated in a commercial environment. This equipment generates, uses, and can radiate radio frequency energy and, if not installed and used in accordance with the instructions in this guide, may cause interference to radio communications. Operation of this equipment in a residential area is likely to cause interference, in which case the user will be required to correct the interference at his own expense.

The user is cautioned that changes and modifications made to the equipment without approval of the manufacturer could void the user's authority to operate this equipment. It is suggested that the user use only shielded and grounded cables to ensure compliance with FCC Rules.

If this equipment does cause interference to radio or television reception, the user is encouraged to try to correct the interference by one or more of the following measures:

- Reorient the receiving antenna.
- Relocate the equipment with respect to the receiver.
- Move the equipment away from the receiver.
- Plug the equipment into a different outlet so that equipment and receiver are on different branch circuits.

If necessary, the user should consult the dealer or an experienced radio/television technician for additional suggestions.

## Canada Class A Statement

This equipment does not exceed Class A limits per radio noise emissions for digital apparatus, set out in the Radio Interference Regulation of the Canadian Department of Communications.

### **Avis de conformité aux normes du ministère des Communications du Canada**

Cet équipement ne dépasse pas les limites de Classe A d'émission de bruits radioélectriques pour les appareils numériques, telles que prescrites par le Règlement sur le brouillage radioélectrique établi par le ministère des Communications du Canada.

## JATE

This equipment meets the requirements of the Japan Approvals Institute of Telecommunications Equipment (JATE).

## CISPR22 Class A warning

This is a Class A product. In a domestic environment, this product may cause radio interference. Under such circumstances, the user may be requested to take appropriate countermeasures.

## VCCI

This is a Class A product based on the standard of the Voluntary Control Council for Interference by Information Technology Equipment (VCCI). If this equipment is used in a domestic environment, radio disturbance may arise. When such trouble occurs, the user may be required to take corrective actions.

この装置は、情報処理装置等電波障害自主規制協議会（VCCI）の基準に基づくクラスA情報技術装置です。この装置を家庭環境で使用すると電波妨害を引き起こすことがあります。この場合には使用者が適切な対策を講ずるよう要求されることがあります。

## Class A Warning for Taiwan and Other Chinese Markets

This is a Class A Information Product. When used in a residential environment, it may cause radio frequency interference. Under such circumstances, the user may be requested to take appropriate countermeasure.

警告使用者：  
這是甲類的資訊產品，在居住的環境中使用時，可能會造成射頻干擾，在這種情況下，使用者會被要求採取某些適當的對策。

# Translated Safety Warnings

## Chassis Lifting Warning

Two people are required when lifting the chassis. Due to its weight, lifting the chassis unassisted can cause personal injury. Also be sure to bend your knees and keep your back straight when assisting with the lifting of the chassis.

**Français:** Le châssis doit être soulevé par deux personnes au minimum. Pour éviter tout risque d'accident, maintenez le dos droit et poussez sur vos jambes. Ne soulevez pas l'unité avec votre dos.

**Deutsch:** Hinweise zur Anhebung des Chassis Zum Anheben des Chassis werden zwei Personen benötigt. Aufgrund des Gewichts kann das Anheben ohne Unterstützung zu Personenschäden führen. Heben Sie das Chassis aus den Knien und halten Sie den Rücken gerade wenn Sie beim Anheben des Chassis assistieren.

**Español:** Se requieren dos personas para elevar el chasis. Para evitar lesiones, mantenga su espalda en posición recta y levante con sus piernas, no con su espalda.

## Blank Panels Warning

Because they regulate airflow and help protect internal chassis components, blank cover plates should remain installed at empty module slots and power supply bays at all times.

**Français:** Les caches blancs remplissent trois fonctions importantes: ils évitent tout risque de choc électrique à l'intérieur du châssis, ils font barrage aux interférences électromagnétiques susceptibles d'altérer le fonctionnement des autres équipements et ils dirigent le flux d'air de refroidissement dans le châssis. Il est vivement recommandé de vérifier que tous les caches, modules d'alimentation et plaques de protection sont en place avant d'utiliser le système.

**Deutsch:** Die leeren Modulblenden schützen interne Komponenten und leiten den Luftstrom. Deshalb müssen in allen unbelegten Slots die Modulblenden immer installiert bleiben.

**Español:** Las tapaderas blancas regulan la circulación de aire y ayudan a proteger componentes internos del chasis y siempre deben estar instaladas en las ranuras vacías del chasis y fuentes de alimentación.

## Electrical Storm Warning

To avoid a shock hazard, do not connect or disconnect any cables or perform installation, maintenance, or reconfiguration of this product during an electrical storm.

**Français:** Ne pas travailler sur le système ni brancher ou débrancher les câbles pendant un orage.

**Deutsch:** Um elektrische Schläge zu vermeiden dürfen während eines Gewitters and diesem Gerät keine Kabel angeschlossen oder gelöst werden, sowie keinerlei Installationen, Wartungen oder Konfigurationen vorgenommen werden.

**Español:** Para evitar peligro de descargas, no conecte o desconecte ningún cable, ni realice ninguna instalación, mantenimiento o reconfiguración de este producto durante una tormenta eléctrica.

## Installation Warning

Only personnel knowledgeable in basic electrical and mechanical procedures should install or maintain this equipment.

**Français:** Toute installation ou remplacement de l'appareil doit être réalisée par du personnel qualifié et compétent.

**Deutsch:** Dieses Gerät soll nur von Personal installiert oder gewartet werden, welches in elektrischen und mechanischen Grundlagen ausgebildet ist.

**Español:** Estos equipos deben ser instalados y atendidos exclusivamente por personal adecuadamente formado y capacitado en técnicas eléctricas y mecánicas.

## Invisible Laser Radiation Warning

Lasers emit invisible radiation from the aperture opening when no fiber-optic cable is connected. When removing cables do not stare into the open apertures. In addition, install protective aperture covers to fiber ports with no cable connected.

**Français:** Des radiations invisibles à l'œil nu pouvant traverser l'ouverture du port lorsque aucun câble en fibre optique n'y est connecté, il est recommandé de ne pas regarder fixement l'intérieur de ces ouvertures. Installez les caches connecteurs prévus à cet effet.

**Deutsch:** Die Laser strahlen an der Blendenöffnung unsichtbares Licht ab, wenn keine Glasfaserkabel angeschlossen sind. Blicken Sie nicht in die Öffnungen und installieren Sie unverzüglich die Abdeckungen über den Glasfaseranschlüssen.

**Español:** Debido a que la apertura del puerto puede emitir radiación invisible cuando no hay un cable de fibra conectado, procurar no mirar directamente a las aperturas para no exponerse a la radiación.

## Operating Voltage Warning

To reduce the risk of electrical shock, keep your hands and fingers out of power supply bays and do not touch the backplane while the switch is operating.

**Français:** Pour réduire tout risque électrique, gardez vos mains et doigts hors des alimentations et ne touchez pas au fond de panier pendant que le commutateur fonctionne.

**Deutsch:** Um die Gefahr des elektrischen Schlages zu verringern, greifen sie bitte nicht in die Spannungsversorgung und berühren sie nicht die Rückwandplatine während das Gerät arbeitet.

**Español:** Para reducir el riesgo de descargas eléctricas, no meta sus manos y dedos dentro del chasis de la fuente de alimentación y no toque componentes internos mientras que el interruptor está conectado.



## Power Disconnection Warning

Your switch is equipped with multiple power supplies. To reduce the risk of electrical shock, be sure to disconnect all power connections before servicing or moving the unit.

**Français:** Il se peut que cette unité soit équipée de plusieurs raccordements d'alimentation. Pour supprimer tout courant électrique de l'unité, tous les cordons d'alimentation doivent être débranchés.

**Deutsch:** Ihr Gerät ist mit mehreren Netzteilen ausgerüstet. Um die Gefahr des elektrischen Schlages zu verringern, stellen sie sicher, daß alle Netzverbindungen getrennt sind bevor das Gerät gewartet oder bewegt wird.

**Español:** Antes de empezar a trabajar con un sistema, asegurese que el interruptor está cerrado y el cable eléctrico desconectado.

## Proper Earthing Requirement Warning

To avoid shock hazard:

- The power cord must be connected to a properly wired and earth receptacle.
- Any equipment to which this product will attached must also be connected to properly wired receptacles.

### Français:

Pour éviter tout risque de choc électrique:

- Ne jamais rendre inopérant le conducteur de masse ni utiliser l'équipement sans un conducteur de masse adéquatement installé.
- En cas de doute sur la mise à la masse appropriée disponible, s'adresser à l'organisme responsable de la sécurité électrique ou à un électricien.

### Deutsch:

Aus Sicherheitsgründen:

- darf das Netzkabel nur an eine Schutzkontaktsteckdose angeschlossen werden.
- dürfen für den Anschluß anderer Geräte, welche mit diesem Gerät verbunden sind, auch nur Schutzkontaktsteckdosen verwendet werden.

### Español:

Para evitar peligro de descargas:

- Para evitar peligro de descargas asegurese de que el cable de alimentación está conectado a una toma de alimentación adecuadamente cableada y con toma de tierra.
- Cualquier otro equipo a cual se conecte este producto también debe estar conectado a tomas de alimentación adecuadamente cableadas.

## DC Power Supply Connection Warning

For EMC/EMI, each DC/DC power supply requires that the ground wire is connected from each DC/DC power supply to Common Earth Ground.

**Français:** Pour EMC/EMI, pour chaque alimentation DC/DC, il est impératif que le fil de terre soit branché à la prise de terre commune.

**Deutsch:** Zur Erfüllung der EMV-/EMI-Anforderungen muss das Erdungskabel jedes DC/DC-Netzteils an eine gemeinsame Erde angeschlossen werden.

**Español:** Para EMC/EMI, cada fuente de alimentación de CC/CC requiere que el cable de tierra esté conectado desde cada fuente de alimentación de CC/CC a la conexión a tierra común.

## Read Important Safety Information Warning

The *Getting Started Guide* that accompanied this equipment contains important safety information about which you should be aware when working with hardware components in this system. You should read this guide before installing, using, or servicing this equipment.

**Français:** Avant de brancher le système sur la source d'alimentation, consultez les directives d'installation disponibles dans le "Getting Started Guide".

**Deutsch:** Der Getting Started Guide, welcher diese Anlage beiliegt, enthält wichtige Sicherheitsinformationen, über die sie sich beim Arbeiten mit den Hardwareeinheiten bewußt sein sollten. Sie sollten diese Hinweise lesen, bevor sie installieren, reparieren oder die Anlage verwenden.

**Español:** La 'Getting Started Guide' que acompañó este equipo contiene información importante de seguridad sobre la cual usted debe estar enterado al trabajar con los componentes de dotación física en este sistema. Usted debe leer esta guía antes de instalar, usar o mantener este equipo.

## Restricted Access Location Warning

This equipment should be installed in a location that restricts access. A restricted access location is one where access is secure and limited to service personnel who have a special key, or other means of security.

**Français:** Le matériel doit être installé dans un local avec accès limité ou seules les personnes habilitées peuvent entrer.

**Deutsch:** Die Anlage sollte an einem Standort mit beschränktem Zutritt installiert sein. Ein Standort mit beschränktem Zutritt stellt sicher, daß dort nur Servicepersonal mit Hilfe eines Schlüssels oder eines anderen Sicherheitssystems Zugang hat.

**Español:** Este equipo se debe instalar en un sitio con acceso restringido. Un sitio con el acceso restringido es uno seguro y con acceso limitado al personal de servicio que tiene una clave especial u otros medios de seguridad.

## Wrist Strap Warning

Because electrostatic discharge (ESD) can damage switch components, you must follow proper procedures to eliminate ESD from your person and the surrounding area before handling switch components. A grounding wrist strap is provided with your Alcatel-Lucent OmniSwitch 6400 product.

**Français:** L'électricité statique (ESD) peut endommager les composants du commutateur. Pour cette raison Alcatel-Lucent joint à l'envoi du châssis un bracelet antistatique à brancher sur la prise mise à la terre située en bas à droite du commutateur. Vous devrez mettre ce bracelet avant toute intervention hardware.

**Deutsch:** Weil elektrostatische Aufladung (ESD) Teile der Anlage beschädigen könnten, müssen sie sich selbst erden, bevor sie mit der Hardware Installation beginnen. Zu diesem Zweck stellt Alcatel-Lucent ein Erdungsarmband und eine Erdungsöse an der oberen rechten Seite des Chassis zur Verfügung. Um eine sichere Erdungsfunktion des Erdungsarmbandes sicherzustellen, müssen die Netzteile installiert und mit dem Schutzleiter des Versorgungsstromkreises verbunden sein.

**Español:** La descarga electrostática (ESD) puede dañar componentes electrónicos. Usted debe asegurarse que está en contacto con tierra antes de hacer la instalación del equipo. Con este fin, Alcatel-Lucent proporciona una pulsera de muñeca para conectar al chasis en la toma de tierra situada en la parte superior derecha del chasis. Para que la correa de muñeca sea eficaz en la eliminación de ESD, las fuentes de alimentación deben estar instaladas en el chasis y conectadas a enchufes CA con tierra adecuada.

# Instrucciones de seguridad en español

## Advertencia sobre el levantamiento del chasis

Se requieren dos personas para levantar el chasis. Debido a su peso, la elevación del chasis sin ayuda puede causar daños corporales. También es seguro doblar sus rodillas y guardar su espalda derecho al ayudar a levantar el chasis.

## Advertencia de las tapaderas en blanco

Porque regulan la circulación de aire y ayudan a proteger componentes internos del chasis, las tapaderas en blanco deben seguir instaladas en las ranuras vacías del módulo y la fuente de alimentación siempre.

## Advertencia en caso de tormenta eléctrica

Para evitar peligro de descargas, no conecte o desconecte ningún cable, ni realice ninguna instalación, mantenimiento o reconfiguración de este producto durante una tormenta eléctrica.

## Advertencia de instalación

Solamente el personal bien informado en procedimientos eléctricos y mecánicos básicos debe instalar o mantener este equipo.

## Advertencia de radiación láser invisible

Los lasers emiten radiación invisible de la apertura abierta cuando no se conecta ningún cable de fibra óptica. Al quitar los cables no mire fijamente en las aberturas abiertas. Además, instale las cubiertas protectoras de la apertura a las salidas de la fibra sin el cable conectado.

## Advertencia de la batería de litio

Hay un peligro de la explosión si la batería del litio en su chasis se substituye incorrectamente. Substituya la batería solamente por el mismo o el equivalente de tipo de batería recomendado por el fabricante. Deseche las baterías usadas según las instrucciones del fabricante. Las instrucciones del fabricante son como sigue: Devuelva el módulo con la batería del litio a Alcatel-Lucent. La batería del litio será substituida en la fábrica de Alcatel-Lucent.

## Advertencia sobre la tensión de operación

Para reducir el riesgo del choque eléctrico, mantenga sus manos y dedos fuera de la fuente de alimentación y no toque la placa madre mientras que el interruptor está funcionando.

## Advertencia sobre la desconexión de la fuente

Su interruptor esta equipado por fuentes de alimentación múltiples. Para reducir el riesgo de choque eléctrico, asegúrese desconectar todas las conexiones de alimentación antes de mantener o de mover la unidad.

## **Advertencia sobre una apropiada conexión a tierra**

Para evitar peligro de descargas:

- El cable de alimentación debe estar conectado a una toma de alimentación adecuadamente cableada y con toma de tierra.

Cualquier equipo al cual se conecte este producto debe estar también conectado a tomas de alimentación adecuadamente cableadas.

## **Leer “información importante de seguridad”**

La *Guía de “Comenzando a Usar”* que acompaña este equipo contiene información importante de seguridad sobre la cual usted debe saber al trabajar con los componentes de dotación física en este sistema. Usted debe leer esta guía antes de instalar, de usar, o de mantener este equipo.

## **Advertencia de acceso restringido**

Este equipo se debe instalar en una ubicación que restrinja el acceso. Una ubicación con acceso restringido es una donde está seguro y limitado el acceso al personal de servicio que tiene un clave especial, u otros medios de la seguridad.

## **Advertencia de pulsera antiestática**

Debido a que la descarga electrostática (ESD) puede dañar componentes del interruptor, usted debe conectarse a tierra correctamente antes de continuar con la instalación del equipo. Para este propósito, Alcatel-Lucent proporciona una pulsera antiestática y un terminal que pone a tierra situados cerca de la parte superior derecha del chasis. Para que la pulsera antiestática sea eficaz en la eliminación de ESD, las fuentes de alimentación se deben instalar en el chasis y enchufar en las salidas de CA con descarga a tierra.

## **Clase de seguridad**

Cumple con 21CFR 1040.10 y 1040.11 ó sus equivalentes.

## **Advertencia de fuentes de poder**

Las unidades OmniSwitch 6400 pueden estar equipadas con tres cordones para fuente de poder. Para reducir el riesgo de un choque eléctrico, desconecte todos los cordones de fuente de poder antes de dar servicio a la unidad.

